

## Technique Interior

RELEASE JUNE 2020

interior

for  
people  
who  
create

4	Quality
5	Formats
6	Products
8	FunderMax Compact and the Environment
10	Material properties
11	Material characteristics
12	Qualifications
13	Transport and storage
14	Processing recommendations
28	Chemical resistance
35	Cleaning
36	Wall cladding
54	Cubicles
62	Ceilings
66	Table tops
68	Furniture
72	Worktops
80	Wash basins
82	Railings

**NOTE**

PLEASE SEE MORE ABOUT THE LATEST VERSION OF THIS BROCHURE ONLINE AT [WWW.FUNDERMAX.AT](http://WWW.FUNDERMAX.AT)

THE DIAGRAMS IN THIS TECHNICAL INFORMATION ARE SCHEMATICAL REPRESENTATIONS AND ARE NOT TRUE TO SCALE.  
THIS ISSUE REPLACES ALL OTHER ISSUES OF EXTERIOR TECHNIQUES BROCHURES OF FUNDERMAX WHICH WERE PUBLISHED BEFORE.



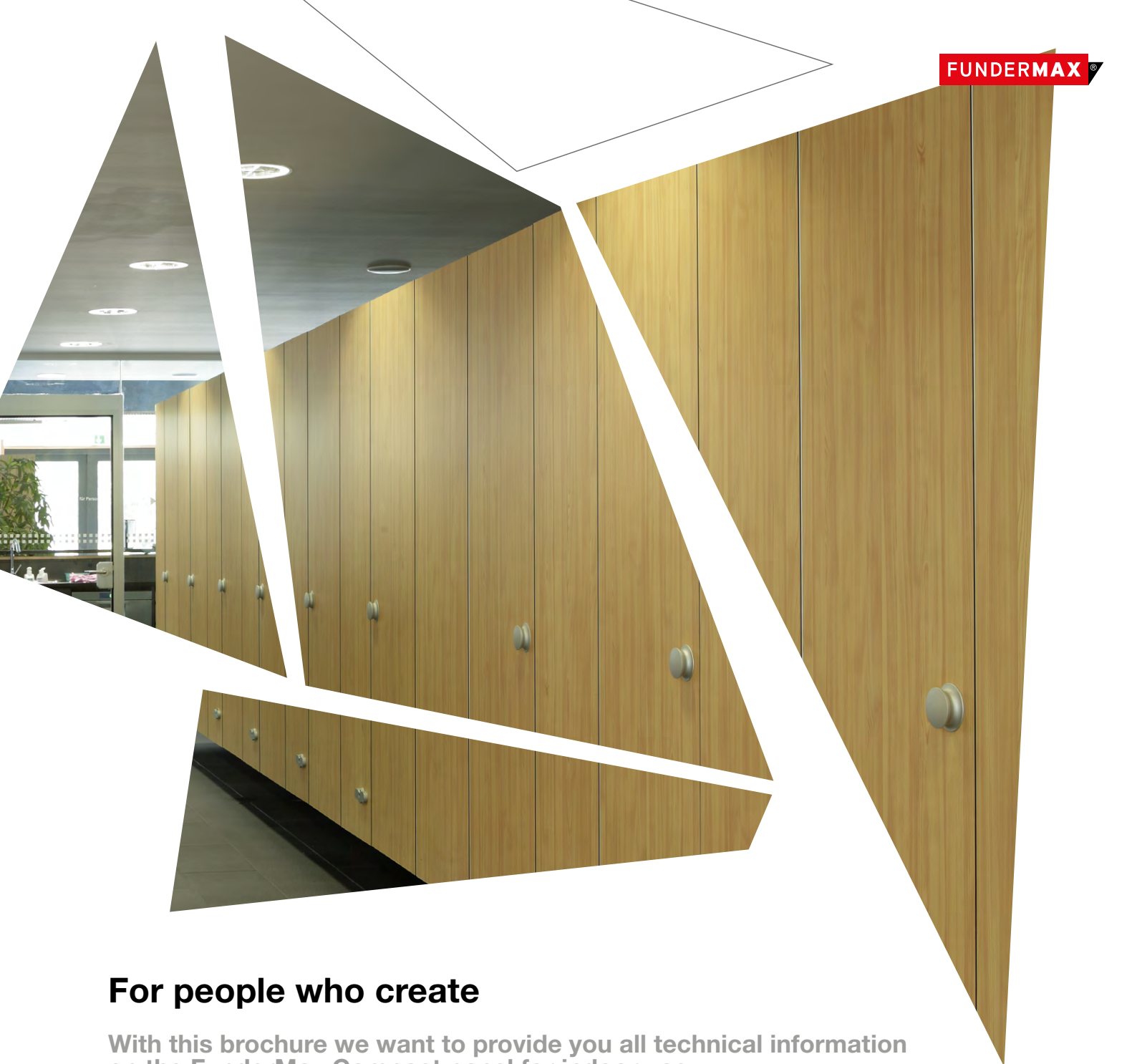

## For people who create

With this brochure we want to provide you all technical information on the FunderMax Compact panel for indoor use.

FunderMax Compact Interior is not only suitable for use in sanitary and wet rooms. The quality of the panels means that it is also suitable for all other indoor usage such as wall cladding, railing infill panels, furniture, tables, desks, column cladding and lab equipment etc.

Due to our wide variety of products, FunderMax Compact Interior can be used for almost any indoor purpose.

You will find a wide range of different examples of use at [www.fundermax.at](http://www.fundermax.at)

If you have any questions which may not be covered in this brochure, please do not hesitate to consult our sales team and the application engineers. We will be more than happy to help.

## What Max Compact Interior can do

FunderMax Compact Interior panels are high-pressure laminate panels (HPL) manufactured to standard EN 438 that are produced in laminate presses under high pressure at high temperature. They are particularly suitable for demanding and decorative applications (e.g. furniture, office furniture, wall cladding, sanitary facilities etc.)...



scratch resistant



easy to clean



solvent resistant



heat resistant



food grade



quick installation



impact resistant



durable

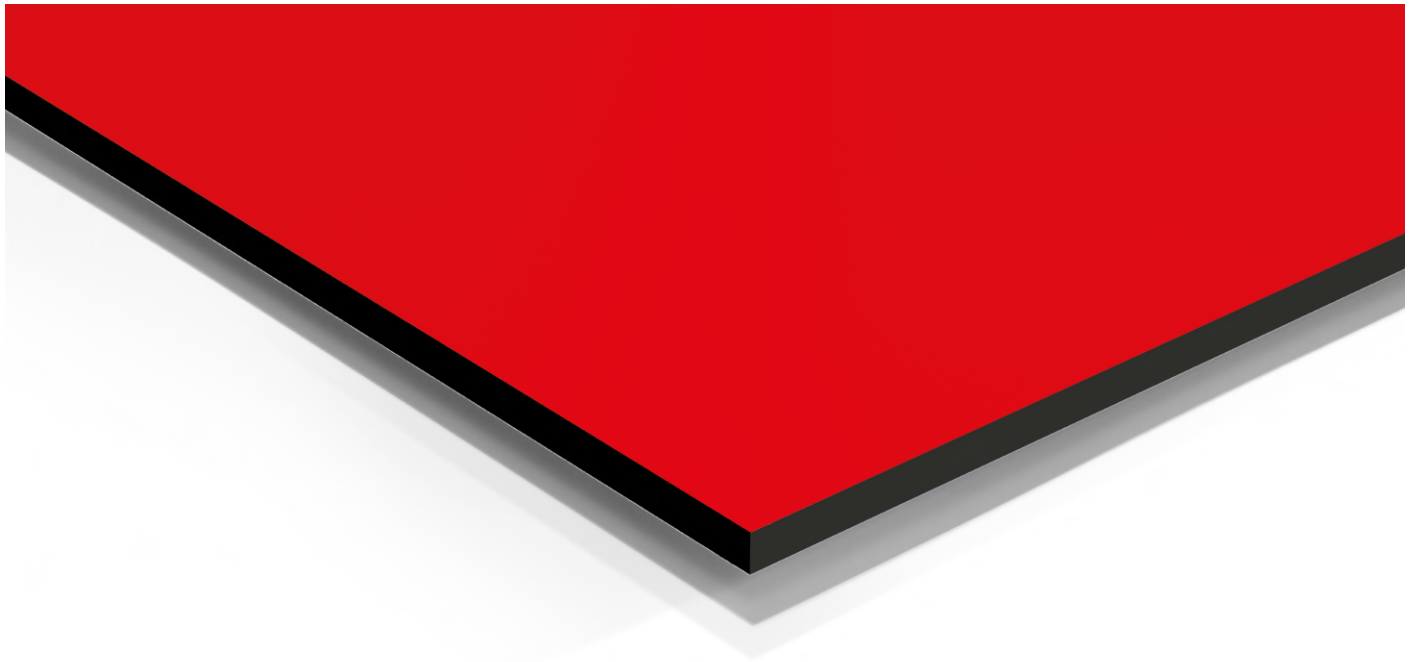

### Properties\*:

scratch resistant  
 solvent resistant  
 food grade  
 heat resistant  
 easy to clean  
 hygienic

impact resistant (EN ISO 178)  
 suitable for all interior applications  
 decorative  
 abrasion proof  
 resistant to chemicals

frost and heat resistant from -80°C to +80°C  
 bending resistant (EN ISO 178)  
 easy to install  
 durable

\*MATERIAL PROPERTIES YOU WILL FIND ON PAGE 10



In this overview you will find available sizes for FunderMax Compact Interior panels together with the different product designs.

We reserve the right to make changes in line with product development. Please note the FunderMax current delivery programme.

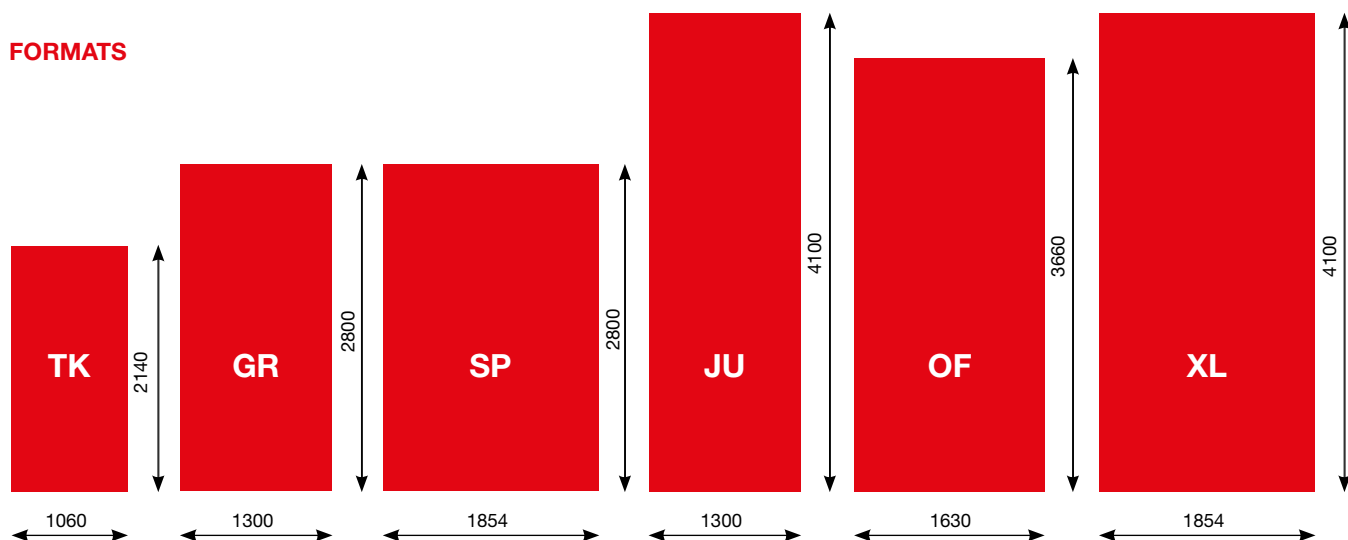

Fig. 1

AVAILABLE FORMATS ACCORDING TO THE PRODUCTS*)						
	TK	GR	JU	SP	OF	XL
Max Compact Interior	●	●	●	●		●
Max Compact Interior Plus		●	●	●		●
Max Resistance <sup>2</sup> (Laboratory panel)					●	
Max Compact with Individualdecor	●	●	●			
Max Compact with white core			●			●

Table 1

\*) RESTRICTED DECOR OR SURFACE POSSIBILITIES ACCORDING TO THE FORMAT. SEE CURRENT DELIVERY PROGRAM.

### Max Compact Interior

As a standard, Max Compact panels come with decors on both sides. The core is black and the surfaces are available in different structures. See our current delivery programme.

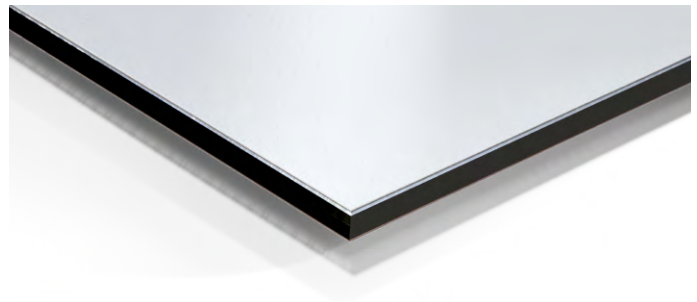

### Max Compact Interior Plus

Max Compact Interior Plus panels have the same qualities as the Compact Interior panels, but are manufactured with a double-hardened, pore-free surface sealed with urethane acrylate for increased surface protection.  
Decors - Please refer to the Decor Collection IP.

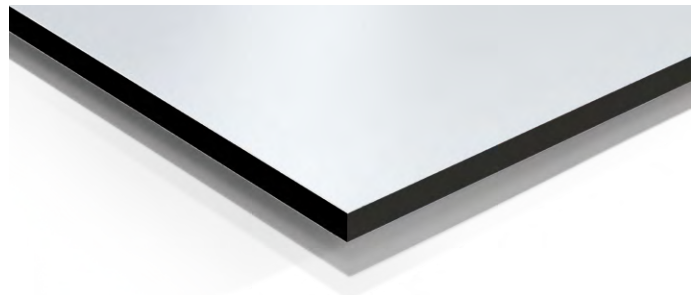

### Max Resistance<sup>2</sup>

Max Resistance<sup>2</sup> panels are Compact Interior panels with an integrated chemical-resistant surface.  
Decor - Please refer to the decor collection Resistance<sup>2</sup> (RE).

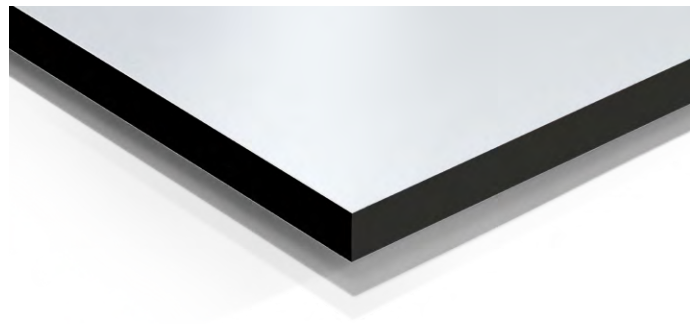

### Max Compact with white core

Though similar in form and function, these Compact panels exhibit the fine stylish difference: The panel core remains an exquisite white. Slight colour differences to the Max Laminate panels and Max Compact panels with a black core are possible. When combining panels, please compare the samples. Decor is always the same on both sides.

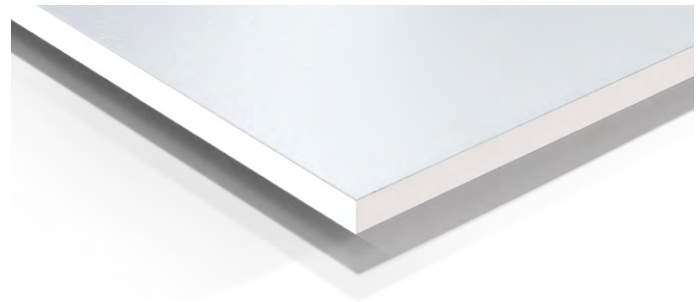

### FunderMax Elements (processing)

FunderMax offers CNC controlled processing and panel cutting. With state-of-the-art devices, it is possible to produce everything: from simple cutouts for mounting the panels, to intricate milling for railing panels or furniture elements. We can make just about anything you can dream up.



### m.look wall protection system

An innovative wall protection system and wall cladding which opens the door to a world full of visual highlights, architecturally limitless ideas and sophisticated technical possibilities. It consists of a large area panel featuring a heavy duty core, with decorative HPL surfaces on both sides according to EN 438.

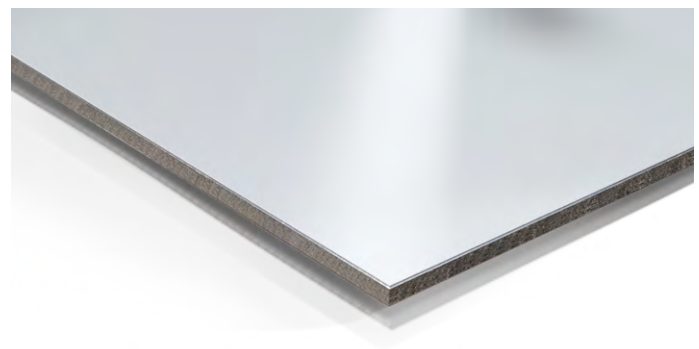

## Resource and Environmentally Friendly Facade Panels

We are specialists in the processing of renewable raw materials – and have been for over 100 years. Our production cycles are closed, production waste is either recycled back into the production process or used to generate energy in our green energy district heating plants. This works so well, that today as a private company we provide district heating to over 8,500 households.



### QUALITY MANAGEMENT SYSTEMS

FunderMax has oriented its production facilities and processes on internationally recognized standards such as ISO 9001, ISO 14001, ISO 50001 and ISO 45001. This fact gives all customers the assurance that they have in their hands a high-quality construction product. And in its procurement of raw materials and intermediate products, FunderMax orients itself on up-to-date standards such as FSC® and PEFC™\*.

\*PLEASE FIND FURTHER INFORMATION AT  
WWW.FUNDERMAX.AT.

### SUSTAINABLE PRODUCTION

Max Compact Interior is made from natural fibre panels — around 65%, by weight — consisting largely of wood that has been processed into “kraft papers”. This wood is a by-product of sawn lumber production or of sawmills. We source these raw materials from vendors certified according to the standards FSC® or PEFC™. These standards ensure that the wood is produced in compliance with internationally applicable rules for sustainable forestry.

The kraft papers are impregnated with synthetic resins in impregnation facilities, dried, and pressed into durable, moisture-resistant panels under high pressure and heat. These panels do not contain organic halogen (or chlorine, fluorine, bromine, etc.) compounds such as are found in greenhouse gases or PVC. They contain neither asbestos nor wood protection agents (fungicides, pesticides, etc.) and are free of sulphur, mercury and cadmium.

The exhaust air removed from the drying process is treated using a process of regenerative thermal oxidation, with the resulting heat being fed back into said drying process. For its installation of this efficient exhaust air treatment, FunderMax was awarded the “Klima:aktiv” award for best practices by the Austrian Energy Agency and the Austrian Federal Ministry of the Environment. This avoids CO<sub>2</sub> emissions of ca. 10,000 tons annually at the production site.





### **LONG-LASTING AND MAINTENANCE-FREE**

Extensive tests certify the exceptional durability of Compact Interior panels. The production process ensures a highly resistant surface. FunderMax Compact Interior panels do not require any maintenance to ensure a long service life. The surface of the panels is highly resistant to soiling. If necessary, they can be cleaned with standard cleaning agents. It is not necessary to seal the edges, even after cutting. The robust surface is also suitable for highly stressed applications such as ramming protection and is highly resistant to impact marks.

### **WASTE DISPOSAL**

Chips and shavings produced by processing (cutting and milling) are not hazardous to human health. This also means that waste can even be disposed of thermally without the emission of environmental toxins such as hydrochloric acid, organic chlorine compounds or dioxins, assuming modern heating systems. At appropriately high temperatures, and assuming both sufficiently long retention of the combustion gas in the combustion space and a sufficient oxygen supply, Max Compact Exterior decomposes into carbon dioxide, nitrogen, water and ash. The energy emitted via this process can be put to use. Disposal in properly managed commercial waste disposal sites is unproblematic. As a matter of principle, country-specific laws and regulations with regard to disposal must be adhered to.

FUNDERMAX COMPACT INTERIOR PANELS (HPL) ACC. TO EN 438 PROPERTIES TESTED

Properties tested in acc. to EN 438-2	Unit of measurement	Max Compact		Max Compact IP		Max Resistance <sup>2</sup>		Max Compact with white core	
		Standard <sup>1)</sup>	Value	Value	Value	Value	Standard <sup>1)</sup>	Value	
Type acc. to EN 438			CGS	CGF	CGS	CGF			BCS

PHYSICAL DATA

Apparent density DIN 52350/ISO 1183	g/cm <sup>3</sup>	≥ 1.35	≥ 1.35	≥ 1.35	≥ 1.35	≥ 1.35	≥ 1.35	≥ 1.4	1.4
Thickness (Sample) EN 438-2:2016, Point. 5	mm		10	10	10	10	10		10
Weight	kg/m <sup>2</sup>		13.5	13.5	13.5	13.5	13.5		14.0

MECHANICAL PROPERTIES

Resistance against stress abrasion <sup>2)</sup> EN 438-2:2016, Point 10	U	≥ 150	≥ 150	≥ 150	≥ 150	≥ 150	≥ 450 <sup>5)</sup>	≥ 150	≥ 150
Falling ball impact resistance <sup>2)</sup> EN 438-2:2016, Point 21	mm	≤ 10	8	8	8	8	8		
Resistance against scratching <sup>2)</sup> EN 438-2:2016, Point 25	Degree/ scratch hardness	≥ 3 ≥ 4 N	3 4 N	3 4 N	3 4 N	3 4 N	3 - 4 4 - 6 N	3 4 N	3 4 N
Flexural strength EN ISO 178 <sup>2)</sup>	MPa	≥ 80	≥ 80	≥ 80	≥ 80	≥ 80	≥ 80	≥ 80	≥ 80
E-Modulus EN ISO 178 <sup>2)</sup>	MPa	≥ 9000	≥ 9000	≥ 9000	≥ 9000	≥ 9000	≥ 9000	≥ 9000	≥ 9000
Susceptibility to cracking <sup>2)</sup> EN 438-2:2016, Point 24		≥ 4	≥ 4	≥ 4	≥ 4		≥ 4	≥ 3	≥ 4

THERMAL PROPERTIES

Dimensional changes during climatic changes, measured at elevated temperatures <sup>2)</sup> EN 438-2:2016, Point 17	length %	≤ 0.3	≤ 0.3	≤ 0.3	≤ 0.3	≤ 0.3	≤ 0.15	≤ 0.5	≤ 0.5
	cross %	≤ 0.6	≤ 0.6	≤ 0.6	≤ 0.6	≤ 0.6	≤ 0.30	≤ 0.8	≤ 0.8
Resistance to boiling water EN 438-2:2016, Point 12 <sup>2)</sup>	%	≤ 2.0 (CGS) ≤ 3.0 (CGF)	≤ 2.0	≤ 3.0	≤ 2.0	≤ 3.0	≤ 2.0		
Coefficient of thermal expansion EN 61340-4-1	1/K		20 x 10 <sup>-6</sup>	20 x 10 <sup>-6</sup>	20 x 10 <sup>-6</sup>	20 x 10 <sup>-6</sup>	20 x 10 <sup>-6</sup>		
Thermal conductivity I	W/mK		approx. 0.3	approx. 0.3	approx. 0.3	approx. 0.3	approx. 0.3		
Resistance to vapour diffusion			17.200μ		17.200μ		17.200μ		
Surface resistance DIN 53482	Ohm		10 <sup>9</sup> -10 <sup>12</sup>	10 <sup>9</sup> -10 <sup>12</sup>	10 <sup>9</sup> -10 <sup>12</sup>	10 <sup>9</sup> -10 <sup>12</sup>	10 <sup>9</sup> -10 <sup>12</sup>		
Resistance to dry heat (160°C) EN 438-2:2016, Point 16	Degree	≥ 4	≥ 4	≥ 4			≥ 4	≥ 4	≥ 4

OPTICAL PROPERTIES

Light fastness no. EN 438-2:2016, Point 27 <sup>3)</sup>	Level	≥ 4	≥ 4	≥ 4	≥ 4	≥ 4	≥ 4	≥ 4	≥ 4
--	-------	-----	-----	-----	-----	-----	-----	-----	-----

Table 1

FIRE BEHAVIOR

	COMPACT INTERIOR TYP CGS	COMPACT INTERIOR F-QUALITÄT TYP CGF
<b>Reaction to fire classification</b>		
Europa EN 13501-1 Euroclass	D-s2, d0	B-s2, d0/B-s1, d0 <sup>4)</sup>
Austria A3800/1	schwer brennbar Tr1, Q1	schwer brennbar Tr1, Q1
Switzerland fire classification		5(200°)3
Germany DIN 4102	B2 - normal entflammbar	B1 - schwer entflammbar

Table 2

FOR THE SURFACE FH AND IP SUPPLIES A GLOSS DEGREE TOLERANCE OF ±5 GE MEASURED AT 60°

1) ACCORDING TO EN 438

2) AVERAGE VALUES OF PRODUCTION CONTROL

3) GREY SCALE ACCORDING TO DURATION OF EXPOSURE TO BLUE TEXTILE REFERENCE STRIPES 6

4) FOR 6-20 MM AT MOUNTING WITH MAX. 15 MM REAR VENTILATION ACCORDING TO CLASSIFICATION REPORT MA39-VFA2019-1215

5) 450 U FOR UNI DECORS, 150 U FOR PUNTO DECORS

**MATERIAL CHARACTERISTICS AND EXPANSION CLEARANCE**

Max Compact panels do not only react to temperature but primarily to moisture in relation to the climactic conditions of the respective storage or mounting area. If both of these influential factors affect one side of the panel only, it can lead to variations of flatness depending on the period of exposure. Please take note of our advice concerning ventilation, storage and stack coverage.

Max Compact shrinks when it loses moisture!  
 Max Compact expands when it absorbs moisture!  
 When working and constructing with the panels, thought must be given to this possible dimensional change. For Max Compact it is basically half as much lengthways as widthways (see properties on page 8; lengthways is relative to the nominal panel format!).

Metal substructures experience dimensional changes when exposed to variations in temperature. However, the dimensions of Max Compact also change under the influence of increasing relative air moisture. These dimensional changes of the substructures and cladding materials may work in opposing directions. Therefore, it is important to ensure sufficient room for expansion.

As a general rule for necessary expansion clearance:

Element length = a  
 Element width = b

$$\frac{a \text{ oder } b \text{ (in mm)}}{500} = \text{Expansion Clearance}$$

**TEMPERATURE RESISTANCE**

Max Compact Interior panels remain dimensionally stable up to 80°C of constant temperature load.

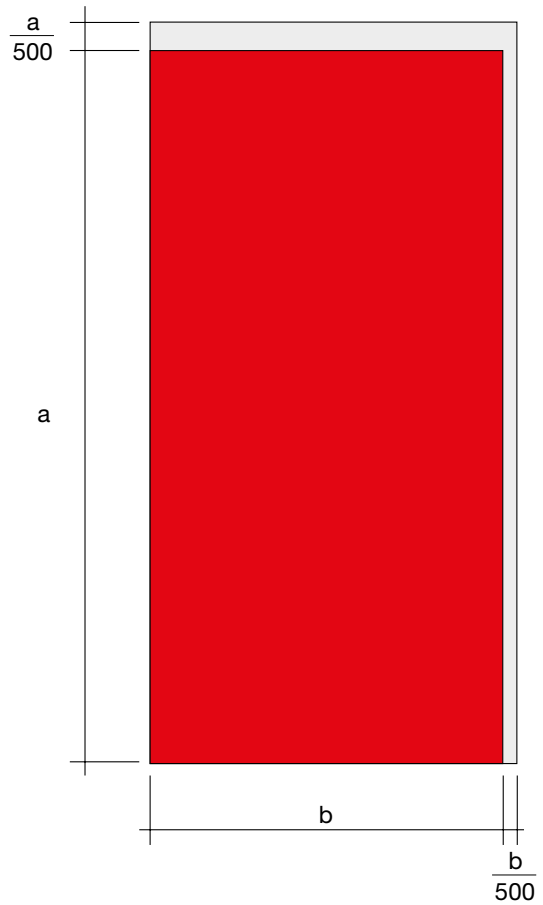

Fig. 1

For Max Compact panels types CGS and CGF, OFI CERT as a global authorisation body confirms the compliance of quality standards in accordance with EN 438.

### HYGIENE

Preventive hygiene is important in many areas. The surface of FunderMax panels distinguished by their easy cleaning, maintenance, desinfected and harmlessness in food contact applications.

The validity of each of the respective test certificates should be noted. You can find the current certificates on our homepage at: ,[www.fundermax.at](http://www.fundermax.at)' under ,Downloads' – ,technical approvals'.

Please take note of the valid standards, regulations and guidelines for the permitted use of materials in relation to fire performance and fall protection.



Fig. 1

# Guidelines for handling Max Compact Interior panels

## TRANSPORT AND HANDLING

Handle Max Compact Interior panels with care in order not to damage the edges and surfaces of the high-quality material. In spite of the excellent surface hardness and the installation protection film, the stack weight of Max Compact Interior panels is a possible cause of damage. Therefore, any form of dirt or dust between the panels must definitely be avoided.

Max Compact Interior panels must be secured against slippage during transport. When loading or unloading, the panels must be lifted. Do not push or pull them over the edge (see Fig. 2)

**Transport protection films must always be removed from both sides at the same time.**

Maybe there is a stronger adhesion of the foils on the surface because of the storage. Therefore there might be a higher effort to remove the foil. That does not have any effect to the quality of the product and does not result into a complaint. The transport protection film must not be exposed to heat or direct sunshine.

## HINT FOR FINAL CLEANING

Please ensure that foreign substances (e.g. drilling and machine oils, greases, adhesive residues, etc.) that soil the surface of the Max HPL panels during storage, installation and use are removed immediately without leaving any residue. We recommend using non-greasy sunscreens (e.g. Physioderm Physio UV 50 Spray), as soiling with conventional sunscreens is often impossible to remove completely even when cleaned immediately. No responsibility will be accepted for any complaints regarding color, gloss and surface of the panels should these recommendations fail to be observed. For details on how to properly clean Max Compact Interior panels, see page 35.

## STORAGE AND AIR CONDITIONING

Max Compact Interior should always be left in the original packaging. The panels should be stacked horizontally on a flat, stable and padded raised surface. If this is not possible, the panels can be temporarily stored as shown in Fig. 4. The panels must lie completely flat. After removing the panels, the original packaging should be closed again.

Cover plates must always be left on the stack (see Fig. 3). The top cover should be weighted down. The same applies, in principle, for cut-panel stacks.

Incorrect storage can lead to permanent deformation of the panels.

Max Compact Interior panels should be stored in closed rooms under normal climatic conditions, temperature about 15°C - 25°C and relative humidity at about 40% - 60%. Climate differences on the two surfaces of a panel are to be avoided.

With pre-installed fastening elements, therefore, care is to be taken that the climatic effect is uniform on all sides. Use intermediate layers of wood or plastic (see Fig. 5).

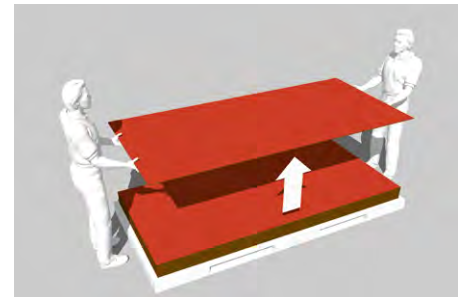

Fig. 2



Fig. 3

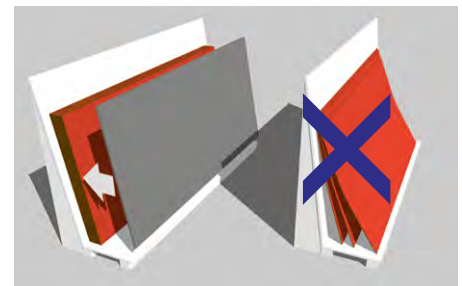

Fig. 4

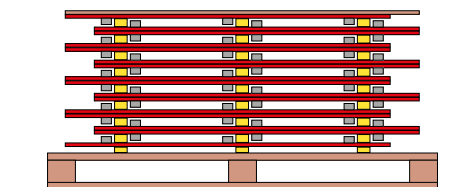

Fig. 5

## General processing guidelines

When working with FunderMax Compact Interior panels the ratio between the number of teeth (z), the cutting speed ( $v_c$ ) and the feed rate ( $v_f$ ) must be observed.

	$v_c$	$f_z$
	m/s	mm
Saw	40 – 60	0.02 – 0.1
Mill	30 – 50	0.3 – 0.5
Dill	0.5 – 2.0	0.1 – 0.6

Table 1

### CALCULATION OF CUTTING SPEED

$$v_c = D \cdot \pi \cdot n / 60$$

$v_c$  – cutting speed

D – tool diameter [m]

n – tool rotational speed [min<sup>-1</sup>]

### CALCULATION OF FEED SPEED

$$v_f = f_z \cdot n \cdot z / 1000$$

$v_f$  – feed rate [m/min]

$f_z$  – tooth feed

n – tool rotational speed [min<sup>-1</sup>]

z – number of teeth

### CUTTING MATERIAL

Tools with hard blades (e.g. HW-Leitz) can be used.

In order to extend tool life, the use of DP-tipped tools (DP polycrystalline diamond) is recommended.

### GENERAL ADVICE

If chip removal is not carried out regularly, this can quickly lead to damage of the blade. As a result the required engine power is increased and the tool life will be shortened. If the shavings are too small they will then scrape and eventually blunt the tool, therefore leading to a short tool life.

## Tooth forms

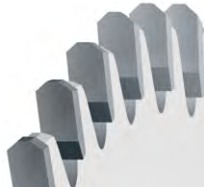

Fig. 1

### TR/TR (TRAPEZOID TOOTH/TRAPEZOID TOOTH)

Preferred tooth forms for the cutting of hard abrasive laminates.



Fig. 2

### FZ/TR (FLAT TOOTH/TRAPEZOID TOOTH)

Tooth form for the processing of laminates and Compact Interior.



Fig. 3

### WZ/FA (VARIABLE TOOTH WITH BEVEL)

An alternative to FZ/TR tooth

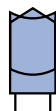

Fig. 4

### HZ/DZ (CONCAVE TOOTH WITH BEVEL)

Tooth forms for excellent and below on machines without scoring units.



Fig. 5

### HZ/FA (CONCAVE TOOTH WITH BEVEL)

Similar use to HZ/DZ only with longer Machine life without scoring units.

For single cuts, it is imperative that the vibration of the panels is prevented using used panels.

Stack height is in compliance with machine capacity.

## The processing of Max Compact Interior panels

### GENERAL

The surface area of FunderMax Compact Interior panels contains high-quality melamine resins and is therefore highly resistant. The processing properties of the FunderMax Compact Interior panels are similar to those for the processing of hardwood. Hard metal cutting tools have been tested and are indispensable when working with FunderMax Compact Interior panels. If a long tool life is required, diamond-tipped (DP) tools should be used. Sharp blades and smooth functioning are both necessary elements to ensure a faultless processing of the material. Breaking-off, splintering and chipping of the decorative side is a result of incorrect handling or unsuitable tools. Machine tables should be as flat and smooth as possible, so that no chips collect - which can damage the surface area. The same also applies for work surfaces and the controlling of hand-held machines.



Fig . 6

## Safety measures

This is simply a list of the recommended personal protective equipment. The standard required protective equipment for the given field of work should be used (work clothes, safety boots, hairnets,...).

### GLOVES

Non-bevelled cut edges are sharp and pose a risk of injury. To protect against the handling of freshly cut FunderMax Compact panels, gloves of protection category ii with a minimum cut resistance of 2 should be used.



EN 388		Mechanical risks	
		the higher the digit, the better the test result	
Test resistance	Digit	Test resistance	Digit
Abrasion	0 - 4	Abrasion	0 - 4
Bladecut	0 - 5	Bladecut	0 - 5
Tear	0 - 4	Tear	0 - 4
Puncture	0 - 4	Puncture	0 - 4

### PROTECTIVE

As with the manufacturing of any other wood, tightly-sealed eye protectors must be worn when working with Max Compact Interior.



### DUST PROTECTION

As with the manufacturing of any other wood, the processing of Max Compact Interior panels can create dust. For sufficient respiratory protection, dust mask filters for e.g. should work.



### HEARING PROTECTION

During the mechanical treatment of Max Compact Interior the sound level can rise to above 80 dBA. Please ensure that you have adequate ear protection at all times when working with these materials.



## Cutting

### VERTICAL PANEL SPLITTING, TABLE AND SLIDING TABLE SAWS WITHOUT SCORING UNIT

For circular saw blades with a positive rake angle and saw shaft under the work piece. Due to the positive rake angle, the cutting pressure takes effect using the stable table support.

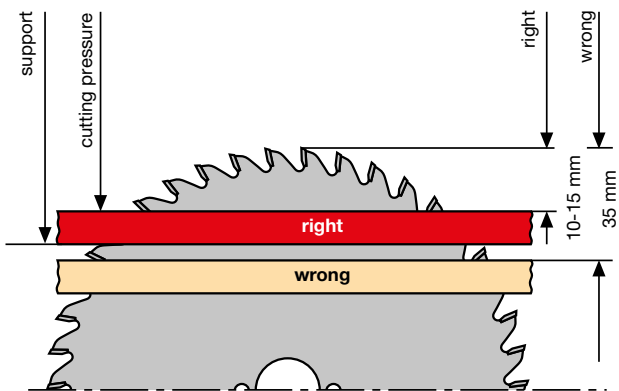

Fig. 1

For circular saw blades with a negative rake angle and saw shaft above the work piece. Through the negative rake angle, the cutting pressure takes effect using the stable table support.

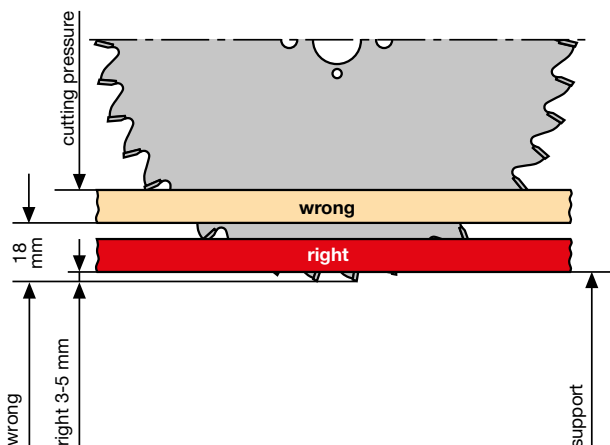

Fig. 2

### Adjustment

- visible side upwards;
- very narrow saw guide;
- smooth alignment of the FunderMax Compact Interior panels on the workbench with the saw blade;
- correct blade protrusion.

Depending on the blade protrusion, the entrance and exit angles and therefore the quality of the cutting edges will change. If the upper cutting edges are unclear, the saw blade will need to be adjusted to a higher level. The saw blade must be adjusted to a lower level for an unclear cut of the underside. This is how the best height adjustment is determined.

### SLIDING TABLE SAWS AND PANEL SPLITTING MACHINES WITH SCORING UNIT AND PRESSURE BEAMS.

#### Scoring circular saw blade:

In order to achieve a good cutting edge quality on the saw exit side, the use of a scoring unit is recommended. The cutting width of the scoring circular saw blade is slightly bigger than that of the main circular saw blade so that the exiting teeth of the main saw no longer touch the cutting edge. As a secure and smooth circulation of the work pieces can only be guaranteed using a pressure device, divided scoring circular saw blades are used on the table and sliding table machines.

Panel splitting unit with scoring aggregate and pressure device.

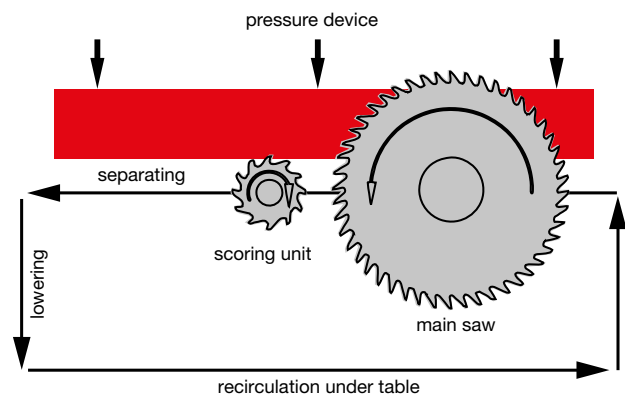

Fig. 3

Cutting width of main saw blade = cutting width rate of the scoring saw

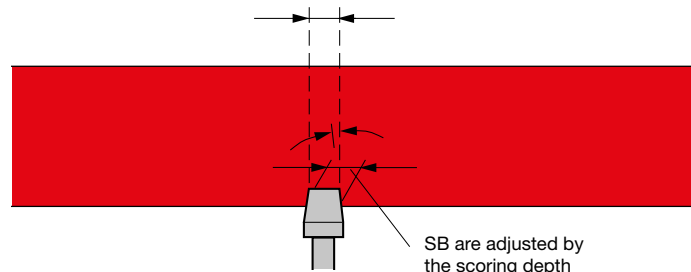

Fig. 4

Operating diagram of the conical scoring circular saw. for the maintenance of tools (always step-by-step), the cutting widths must be aligned with one another.



## Cutting with handheld tools

- For straight cuts with handheld circular saws, a stop bar or guide rail should be used. Saw blades suitable for hard metal use should be used. The sawing takes place from the panel underside using the following tooth forms: variable tooth for coarse cuttings, flat tooth/trapezoid tooth for clean cuts of Max Compact Interior panels and panels which are bonded on both sides.

## Milling machines – edge processing

- Edge processing by hand: for the finishing of edges, files are suitable. The file direction moves from the decorative side to the core. For broken edges, fine files, plane files, sand paper (100-150 grain) or scrapers can successfully be used.
- Edge processing with handheld machines: to mill bevels electric hand planes with bevel or bevel grooves can be used. Hand routers are used along with hard metal tools for special tasks (e.g. wash basin recess, trax-coupling etc.). In order to protect the FunderMax Compact Interior panel surface areas, the supporting surface of the hand routers should be covered with for e.g. panel parts, no felt! Milling shavings should be carefully removed.

We recommend hard metal tipped milling cutters, which are also available with indexable inserts. For a better functioning of your tools, heightadjustable milling cutters are preferable. The sharp edges will be broken down afterwards.

- The processing of edges with stationary machines: for milling work on the FunderMax Compact Interior panels, the optimal ratio of teeth, cutting speed and feed rate should be observed. If the shavings are too small, the machine will scrape (burn) and therefore blunt quickly, meaning it only has a short service life. On the other hand, if the shavings are too big, the edges will be wavy (strokes) with an unclean finish. High rotational speeds are not the only criterion for good quality edges! When working with the hand fed machines, only those with the marking ‚MAN‘ or ‚BG-test‘ should be used. Furthermore, the given machine speed range should neither be exceeded nor fallen short of for reasons of safety. Hand fed machines should only be used when working in the opposite direction.

Milled edges can be finished in the following way: sand the edge surface and smooth out the sharp edges with sandpaper. When processing edges, hand planes with steel residue can be used. It is also recommended that hss blades are used. The cutting angle of the blade should be approx. 15°C.

For the processing of FunderMax Compact Interior panels, milling heads with an HW indexable insert blade or diamond-tipped cutter are suitable.

## Joining

### TO JOIN IN CLIMB OR CONVENTIONAL (E.G. VARIABLE MILLING)

**The following machines are used:**

Spindle moulding machine, edge processing machines and Double-end profiler (hand fed in conventional motion only)

**INFORMATION**

**ON MILLING EQUIPMENT:**

Milling head with reversible blades, divided cuts and reciprocal shaft angle for a splinter-free joining edge.

Machine creates cylindrical finish for large material thickness (approx. 0.10 mm). For completely straight cutting surface, the Diamaster joint cutter WF 499-2 is recommended.

You will find detailed information at company Leitz (supplier advice on page 22).

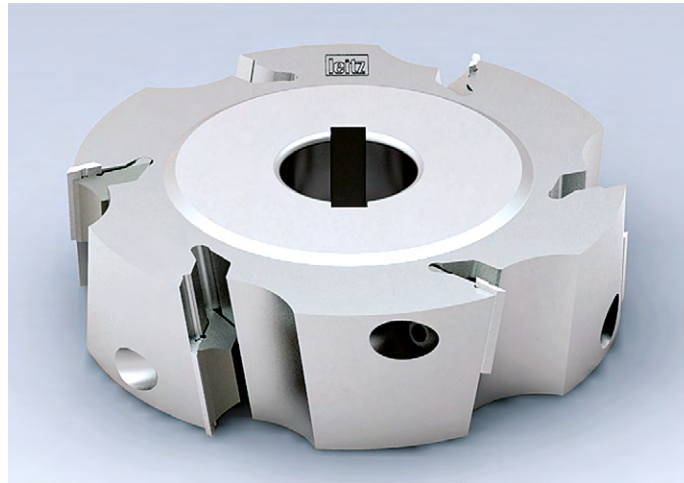

LEITZ JOINT MILLING HEAD-INDEXABLE INSERT MODEL

Fig. 1

### FOR SOUNDPROOF JOINTS ON NARROW WORK PIECE SURFACES CLIMB AND CONVENTIONAL (VARIABLE MILLING)

**The following machines are used:**

Edge processing machines, copy milling machines etc.

**INFORMATION**

**ON MILLING EQUIPMENT:**

Composite tool with mutual shaft angle for a splinter-free joining edge and straight narrow surface. Noise reduction up to 5dBA and highly efficient collection of shavings (over 95%).



LEITZ DIAMASTER JOINT CUTTER DP-TIPPED

Fig. 2

## Routers

For processing using router machines and machining centres, solid hard metal twist or diamond-tipped router drills are best suited. Work pieces must be well clamped and if necessary, additional mechanical tensioners can be used to support the suction cup. It is also recommended that shrink-fit thermoGrip jaw chucks are used instead of collect chucks as they offer the highest stability and stiffness of all known tensioning systems for shaft tools.

**A satisfactory processing result can only be achieved if there is sufficient stiffness in the machine. ‚Light‘ radial machines are only of limited suitability. Ideal: Stiff portal machines.**

### FORMAT, GROOVE AND FINISH MILLING

For high requirements of cut quality - Z3 model for high feed rates.

The following machines are used: Router machines with/without CNC control, machining centres, special milling machines with milling spindles for use with shaft work tools.

#### INFORMATION ON MILLING EQUIPMENT:

Marathon laminate for enhanced service life and reduced gradient for the formation of built-up edges. Usually used for roughing end mills, cutting allowances of approx. 1-2 mm mirror grinding on the rake surface for processing.

### ROUTER CUTTERS FOR FORMATING, AND GROOVING WITH LEDGE FREE CUT

**The following machines are used:** Router machines with CNC control, machining centres, special milling machines with milling spindles for use with shaft work tools.

#### INFORMATION ON MILLING EQUIPMENT:

Negative rake angle of the blade for chip-free finish when grooving and for support of the work piece tensioning for small mill parts. Can be re-sharpened 5 to 8 times with normal blunting. Short, stable cutting blade therefore particularly suited for grooves and shaping of abrasive and hard-to-cut materials.

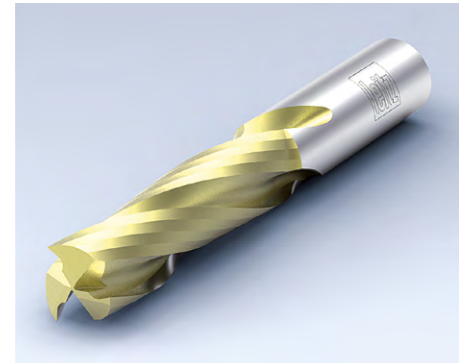

LEITZ SPIRAL ROUTER MACHINE MARATHON FINISH

Fig. 3



LEITZ ROUTER MACHINE DIAMASTER PLUS

Fig. 4

## CNC Processing

The following points should be taken into account when working with Max Compact on CNC devices.

### FIXING PANELS ON A MACHINE TABLE

There are basically two ways to fix or tension Max Compact panels on machine tables depending on the type of processing to be performed:

#### a.) Fixing by means of suction cups

When milling to size or edging both sides of a panel section, it is recommended to fix the panel in place using suction cups at specific points.

NOTICE: The proper distance between the suction cups must be observed!

#### b.) Fixing by means of MDF protective boards

When milling to size, edging one side, making perforations or free-form milling a panel section, it is recommended to fix the panel in place using MDF protective boards (protective boards can be used several times).

The following applies for both options: It must be ensured that the suction cups provide sufficient holding power for the work to be performed. If the suction cups do not provide sufficient fixing or tensioning power, the suction cup seals (e.g. the sealing rings) must be checked.

### SPACING OF THE SUCTION CUPS

As a rule, the material being processed should not be subjected to any vibrations. Therefore, it is important that the suction cups are placed at an appropriate distance from the freely protruding panel edge based on the thickness of the panel.

The following applies: the more suction cups and the smaller the distance from the free protruding edge of the panel, the cleaner the milling pattern. As a rule of thumb, suction cups should be placed in the area to be processed in a grid of max. 300 mm with a maximum distance from the free protruding edge of the panel of no more than 30 mm. The best results are achieved by using an MDF protective board (e.g. 19 mm thick), as this enables a full-surface fixing of the Max Compact panel on the machine table with suction cups.

### CHOICE OF MACHINING TOOL

Generally speaking, Max Compact panels can be machined with solid carbide (VHM) and diamond (PCD) milling tools. The basic prerequisites for a clean milling pattern and a long service life are vibration-free tool holders and spindles. NOTE: The ball bearings must be properly maintained!

Diamond tools have proven particularly suitable for processing a large amount of panels or a high number of running meters. Smooth-running milling cutters with a shank diameter of min. 10 mm in combination with straight continuous DIA cutting edges (2+1 knife) are especially suitable for format milling. It is essential that the feed rate and the cutting speed be adjusted for the specific job and cutter based on the material being processed. We recommend always consulting the tool supplier first.

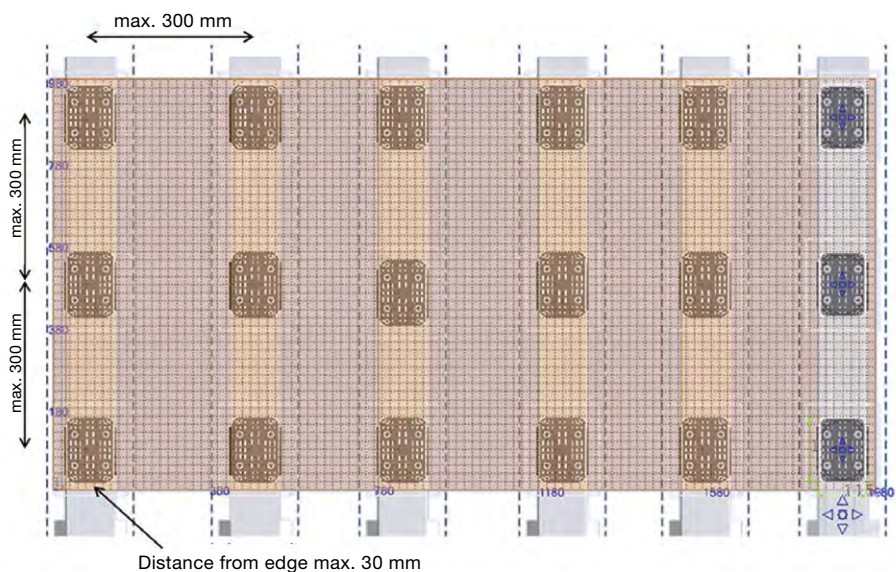

SPACING OF THE SUCTION CUPS

Fig. 1

### **CLAMPING SYSTEM OF THE MILLING TOOL**

It is essential that the spindle be centered in the chuck to ensure the smooth running of the milling cutter. The more centered and play-free the milling cutter can be clamped in place, the better the result. Most machines are equipped with common tool holders such as collets, hydro grips or shrink chucks.

For the professional CNC machining of larger jobs, a hydro grip tool holder or shrink chuck is recommended as they guarantee the best tool clamping. It is important to ensure the proper maintenance of all moving parts such as plain or ball bearings in order to avoid vibrations in every direction!

### **EXTRACTION**

The extraction or the extraction power must be adjusted accordingly for the material being processed to ensure that all the shavings are optimally removed.

If the extraction is not strong enough, there is a risk of heat development. This is due to shavings that remain between the cutter and the panel edge. High friction occurs at this point because the cutter can not eject the material any further. This can lead to burn marks on the panel edge.

### **CNC MACHINING BY FUNDERMAX**

FunderMax has their own machining center - Compact Elements. We are happy to machine Max Compact Interior, Max Compact Exterior, Max HPL and m.look panels to your specifications. Simply contact our customer service center for more information.

## Edges and grooves

Grooved edges on FunderMax Compact panels should always be bevelled, not sharp-edged! This spares the corners of the machine (indexable inserts) and prevents a notch effect. The service life can often decrease dramatically depending on the height adjustment, the machine type and form, the cutting requirements and support material. For high volume production, the use of diamond-tipped machines should be considered.

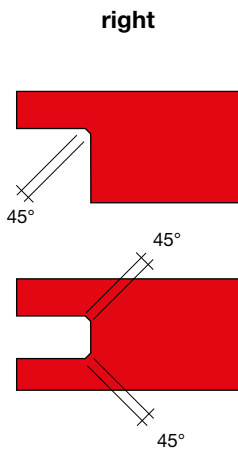

Fig. 1

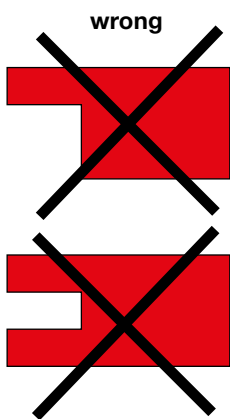
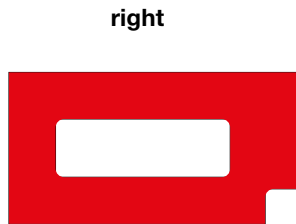

Fig. 2

## Inner notches and cut-outs

With inner notches and milling grooves, the corners are consistently rounded off. The inner radius should be kept as large as possible (minimum radius 5 mm). For inner notches and milling grooves over 250 mm sidelength, the radius must be gradually increased in line with the sidelength. Inner notches can be directly formed using the milling cutter or they can be pre-drilled with a corresponding radius, before the cut from drill hole to drill hole is milled. Sharp-edged corners are weak and lead to the formation of cracks due to tension. Moreover, all edges must be ripplefree. If, sharp-edged corners are required for constructive reasons, this can only be achieved through a combination of compact panel blanks. The suitable cutting, milling and drilling machines for the production of inner notches and milling grooves are described in the previous sections.



MILLING GROOVE IN THE FUNDERMAX COMPACT PANEL

Fig. 3

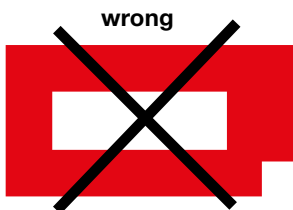

MILLING GROOVE IN THE FUNDERMAX COMPACT PANEL

Fig. 4

## Edge sanding

With standard machines, grain 100 to 120. Edges can also be grinded using sand paper or a scraper. A matte colour finish of the black panel edges can be achieved if combined with silicone-free oil.

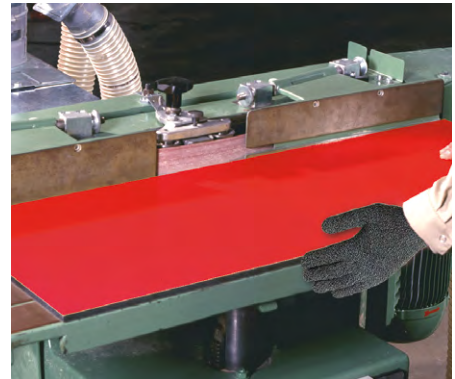

Fig. 5

## Machine suppliers

Leitz GmbH & Co. KG  
Leitzstraße 80  
A-4752 Riedau  
Tel.: +43 (0)7764/8200 – 0  
Fax: +43 (0)7764/8200 – 111  
E-Mail: office.riedau@rie.leitz.org  
www.leitz.org

OERTLI-LEUCO Werkzeuge GmbH  
Industriepark Runa  
A-6800 Feldkirch  
Tel.: +43 (0)5522/75787-0  
Fax: +43 (0)5522/75787-3  
E-Mail: info@oertli.at  
www.oertli.at

Ledermann GmbH & Co. KG  
Willi-Ledermann-Straße 1  
D-72160 Horb am Neckar  
Tel.: +49 (0)7451/93 – 0  
Fax: +49 (0)7451/93 – 270  
E-Mail: info@leuco.com  
www.leuco.com

## Examples of possible edges and corners

For Max Compact Interior panels no edge protection is necessary. For visible edges, there are a wide variety of structural possibilities.

The current data sheet on processing possibilities of FunderMax can be found at: [www.fundermax.at](http://www.fundermax.at) under 'Downloads' – 'ordering facilities'.

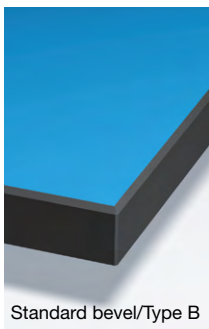

Fig. 6a

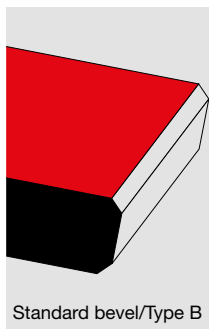

Fig. 6b

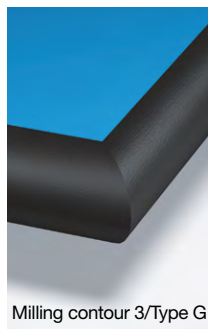

Fig. 10a

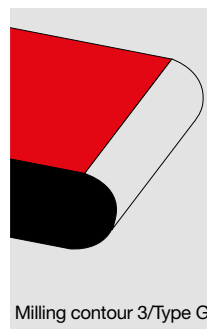

Fig. 10b

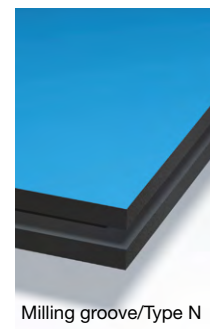

Fig. 14a

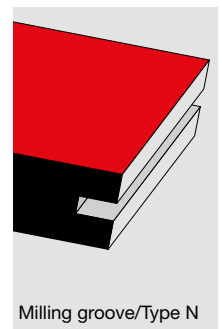

Fig. 14b

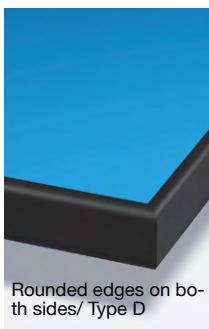

Fig. 7a

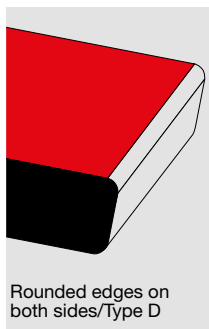

Fig. 7b

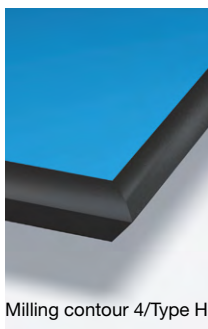

Fig. 11a

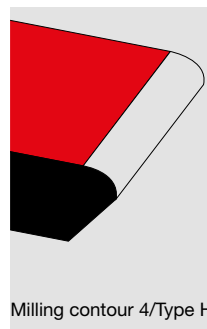

Fig. 11b

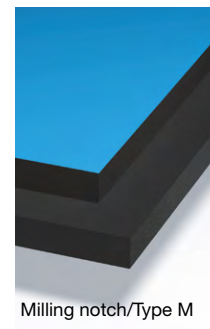

Fig. 15a

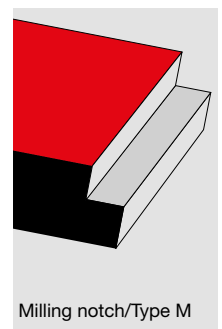

Fig. 15b

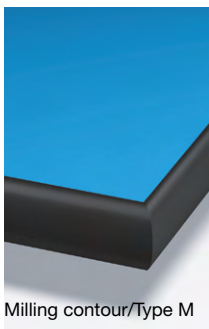

Fig. 8a

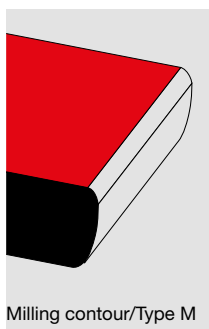

Fig. 8b

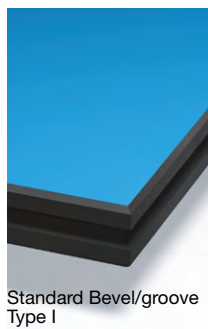

Fig. 12a

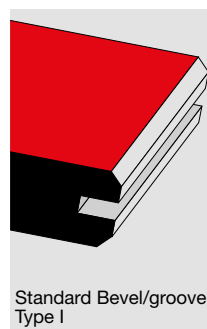

Fig. 12b

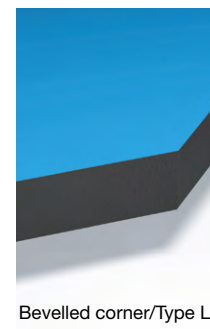

Fig. 16a

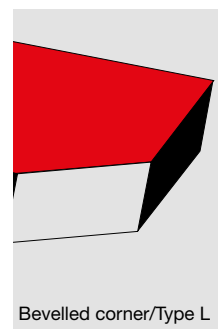

Fig. 16b

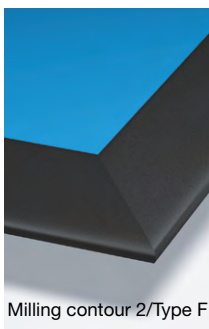

Fig. 9a

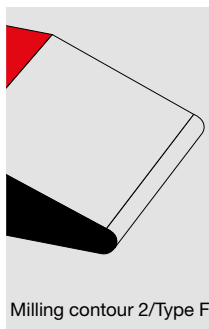

Fig. 9b

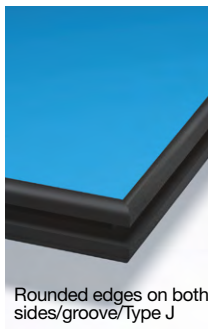

Fig. 13a

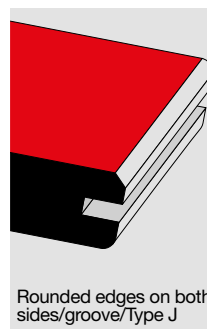

Fig. 13b

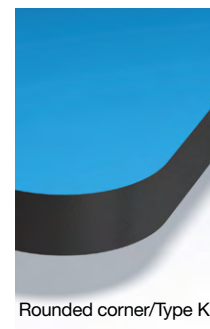

Fig. 17a

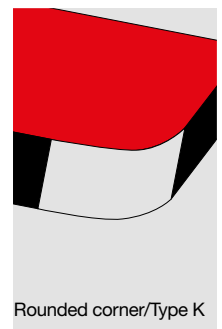

Fig. 17b

## Drilling

Solid hard metal twist or dowel drills are used for drilling. In machining centres, the use of the main spindle instead of the drilling beams for a rpm of 2000 – 4000 min<sup>-1</sup> and a feed rate of 1.5 – 3 m/min, is recommended. The exit speed of the drill must be carefully selected so that the melamine surfaces of the Compact Interior panels are not damaged. Shortly before the drill exits the work piece in full diameter, the feed rate must be reduced by 50%. When drilling through-holes, the counter-pressure should be built up using hardwood or equivalent material to prevent break-offs of the melamine surface.

### For the screwing of blind holes perpendicular to the panel levels, please ensure:

Tap drill diameter (D) = screw diameter minus approx. 1 screw channel depth.

Drilling depth (a) = Panel thickness minus 2 mm after deducting all tolerances.

Screw-in depth = Drilling depth minus 1 mm

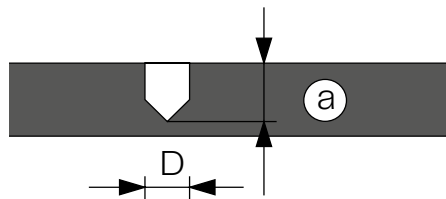

Fig. 1

### For screw fittings parallel to the panel level, please ensure:

- The residual thickness (b) of the Max Compact Interior panel must be at least 3 mm after deducting all tolerances.
- The hole diameter of the drillings parallel to the panel surface must be selected in such a way to avoid any splitting of the compact panels when tightening the screws.
- For screw fittings parallel to the panel surface, metal sheet and chip boardscrews are suitable.
- In order to ensure respective stability, a minimum depth of engagement of 25 mm is necessary.

It is imperative that tests to establish the correct drill diameter are carried out.

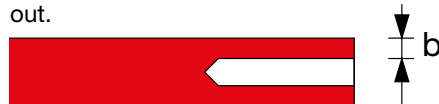

Fig. 2



Fig. 3

For the drilling of Compact Interior panels, drills for plastics are best suited. This means twist drills with a point angle of  $\leq 90^\circ$ . They have a large gradient and chip space. The sharp drill bits mean that these drills are also very suitable for the drilling of through-holes as they cut cleanly through the underside of the material.

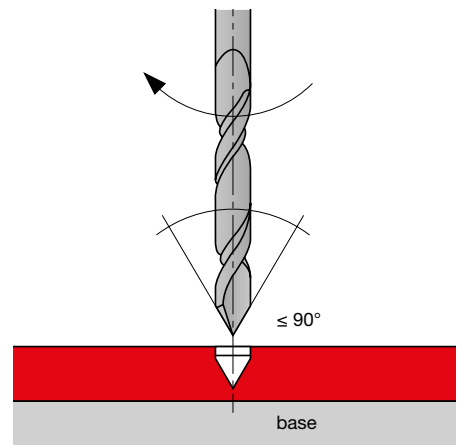

Fig. 4



**UNIVERSAL DRILLING OF BLIND AND THROUGH-HOLES.**

**The following machines are used:**  
Point-to-Point drilling machines, through feed drilling machines, CNC machining centres, box column drill, inlet-fitting drilling machine, drilling units, hand drills.

**INFORMATION ON THE DRILLS:**  
Flat roof drill bits. Shaft diameter identical to blade diameter. Adaptable for shaft-D 10 mm with reducing bush TB 110-0 or PM 320-0-25.



LEITZ-DRILL HW-SOLID, Z2

Fig. 5

Pre-punching ensures better control for hand drilling. Diamond-tipped drills are not suitable for compact panels.

**TIERED HINGE DRILLING**

Particularly for screw-in hinges in door manufacturing.

**The following machines are used:**  
CNC machining centres, drilling units, hand drills.

**INFORMATION ON THE DRILL:**  
Model HW Z 2, 2-tiered. 1tier with roof drill bit.

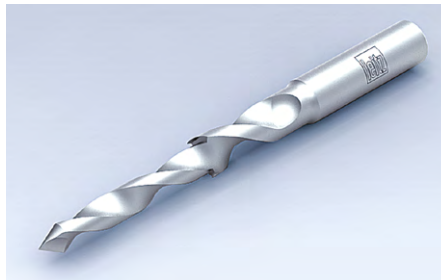

LEITZ-DRILL SHAFT 10 MM

Fig. 6

**DRILLING OF BLIND HOLES**

In particular dowel holes in cabinetry. Particularly suitable for the tear-free drilling of blind holes in visible quality as well as the processing of panel materials. Not suitable for through-holes!

**The following machines are used:**  
Point-to-Point drilling machines, through feed drilling machines, inlet fitting drilling machines, drilling units, CNC machining centres.

**INFORMATION ON THE DRILL:**  
Roughing geometry with extremely clean cut. Model HW-solid with highly wear-resistant HW varieties. High stability and long service life. Polished chip space for minimal friction and feed force.

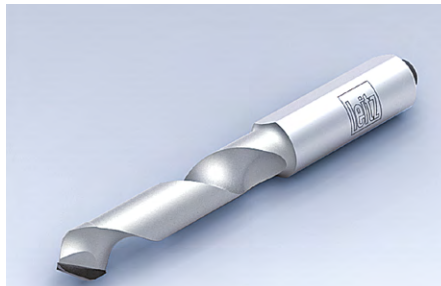

LEITZ-DRILL SHAFT 10 MM

Fig. 7

## Basics

Screws should never come into contact with the edges of the drillhole. They must have clearance on all sides so that the material can adapt to temperature and moisture fluctuations. In this way, the formation of cracks around the holes as well as panel warping, is avoided.

If raised countersunk-head screws are used, underlay rosettes are necessary.

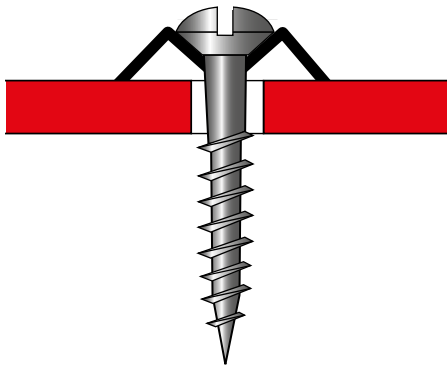

CHEESE-HEAD SCREW WITH UNDERLAY ROSETTES

Fig. 1

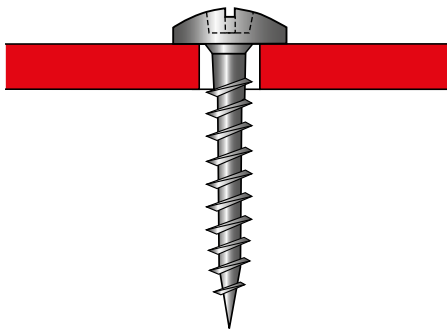

ROUND-HEAD SCREW COVERING SLIDE POINTS

Fig. 2

Attention to V-joints an expansion clearance on plat fragmentations!

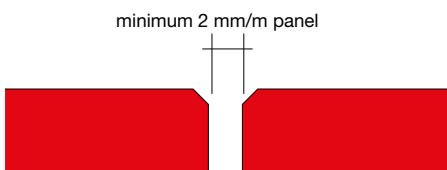

V-JOINTS WITH EXPANSION CLEARANCE

Fig. 3

## Bonded edge joints

In order to increase the adhesive surface, special bevel sections can be milled (Leitz) or, joints with groove or external springs (ideally compact strips) can be produced.

During the adhesive process, it must be ensured that both bonded panels are joined in the same running direction (see construction information page 37).

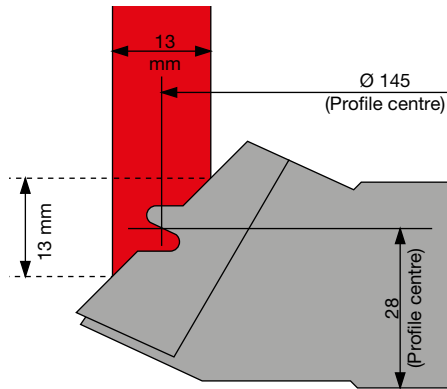

LEITZ PROFILE CUTTER HEAD PRO 610-1-5

Fig. 4

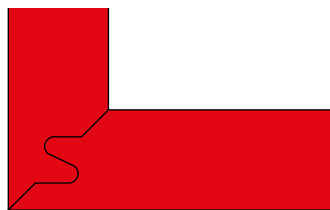

CORNER JOINT WITH LEITZ PROFILE CUTTER

Fig. 5

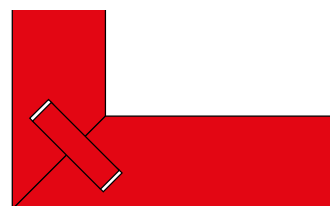

CORNER JOINT WITH GROOVES AND EXTERNAL SPRINGS

Fig. 6

## Glueing

Adhesive joints should be carried out in such a way that dimensional changes of the FunderMax Compact Interior panels are allowed. The panels must only be bonded in the same running direction and conditioning, otherwise tensions may occur (tip: identify decorative design before cutting). FunderMax Compact Interior panels have twice as much shrinkage and swelling room breadth-wise than lengthwise. If adhesive joints are put under frequent pressure, they should be supported using mechanical joints.

### ADHESIVES

#### Dispersion adhesives

e.g. PVAc glues = casein condensation

#### Resin adhesives

e.g. urea, resorcinol and phenolic glues

#### Contact adhesives

e.g. polychloroprene adhesives

#### Reactive adhesives

e.g. epoxy, unsaturated polyester, polyurethane adhesives

#### Hot melt adhesives

for edgebanding, based on EVA, polyamide or polyurethane.

### THE GLUEING OF FUNDERMAX COMPACT ONE BELOW THE OTHER

#### ■ Stiff adhesive joints:

Reactive adhesives such as polyurethane and epoxy glue.

Caution when using PU adhesives.

These adhesives foam and the surface of the Compact panels must be cleaned before the adhesive cures as otherwise only a mechanical cleaning will be possible. This can damage the surface of FunderMax Compact Interior panels. Dispersion adhesives (white glue) and condensation adhesives (PVA glues) are not suitable.

#### ■ Elastic adhesive joints:

The following adhesives can also be used to support mechanical connections.

Adhesions using PUR Kitten e.g.:

Würth 'glues and seals', Sikaflex 252, Teroson-Terostat 92, Dinitrol 600, Dinitrol 605, Dinitrol F500, Dinitrol 410 UV Plus, from Fuller ICEMA 101/25 + curing agent 7 etc. have been tested.

### GLUEING OF FUNDERMAX COMPACT INTERIOR WITH WOOD

After sanding the Max Compact panels, they can be bonded to wood materials using high-quality PVAc glues (white glue). A condition being that the material can absorb the glue moisture during the setting process.

### GLUE APPLICATION PROCESS

The FunderMax Compact Interior panel, as well as the material to be glued, must be thoroughly cleaned before gluing. They must be free of dust, grease, oil and sweat stains or coarse particles that can mark the surface after gluing. When gluing, the ambient climate should be 15 - 25 °C and 50 - 65% relative humidity. The glue joint quality must be selected according to the bonding quality of the substrate and the load. Increased water resistance of the glue joint does not increase the water resistance of the substrate material!

The specifications of the selected adhesive manufacturer must be observed. It is always recommended to test the glue first under local conditions. When working with adhesives, solvents and hardeners, the safety regulations for occupational safety must be observed.

### PRESS TEMPERATURE

Tension-free composite elements can be produced most reliably at pressing temperatures of 20 °C, i.e. room temperature. Higher temperatures allow a reduction in the setting time. However, since the temperature also leads to dimensional changes that may vary between the FunderMax Compact Interior panels and the other materials, 60 °C should not be exceeded in order to avoid increased stress which can lead to the distortion of the elements.

## FunderMax Compact Interior and Star Favorit panels

The focus of this recommendation is a depiction of the chemical resistance of the FunderMax compact panels and the resulting possibilities for application.

Besides their excellent mechanical values, the melamine resin and hygienic pore-free sealed surfaces of the FunderMax Compact Interior and Star Favorit panels mean a high temperature resistance, easy cleaning and a good resistance to chemicals. The stain resistance requirements in accordance with EN 438 are also met.

The Star Favorit panels are stain resistant in accordance with EN 14323.

They can therefore be used when for example:

- Lab and technical chemicals
- Solvents
- Desinfectants
- Dyes (certain types)
- Cosmetics are used on the surface.

Particular attention must be paid to the careful processing of FunderMax Compact Interior panels, as certain requirements may be imposed due to the particular field of use when constructing certain laboratory and medical facilities. For this kind of application we recommend the use of Max Resistance<sup>2</sup> (lab panels).

FunderMax Compact Interior and Star Favorit panels are resistant against many different chemicals. However, several chemicals may still corrode the surface.

Therefore, of crucial importance are:

- The concentration
- Exposure time
- The temperature of substances used

The following lists, although there is no guarantee that they are complete, give an overview of the resistance of FunderMax Compact Interior and Star Favorit panels (at room temperature) against the effects of frequently occurring or used substances (solid, dissolved, fluid, gaseous). When using substances that are not listed, we ask that you enquire further and recommend own sample tests.

To ensure you chose the right product, we strongly recommend that you clearly specify the chemical resistance requirements in advance.



## FunderMax Compact Interior panels

### NO DAMAGE

FunderMax Compact Interior panels are resistant against the following substances and agents.

SUBSTANCE	CHEMICAL FORMULA
Acetic Acid	CH <sub>3</sub> COOH
Acetone	CH <sub>3</sub> COCH <sub>3</sub>
Active charcoal	
Alcohol	ROH
Alcohol, beverages	
Alcohol, primary	RCH <sub>2</sub> OH
secondary	RR'CHOH
tertiary	RR'R''COH
Aldehyde	RCHO
Alum liquor	KAl(SO <sub>4</sub> ) <sub>2</sub> ·12H <sub>2</sub> O
Aluminium chloride	AlCl <sub>3</sub> .aq.
Aluminium sulphate	Al <sub>2</sub> (SO <sub>4</sub> ) <sub>3</sub>
Aluminium potassium sulphate	KAl(SO <sub>4</sub> ) <sub>2</sub>
Amides	RCONH <sub>2</sub>
Amines, primary	RNH <sub>2</sub>
secondary	(RR')NH
tertiary	(RR'R'')N
Ammonia	NH <sub>3</sub>
Ammonium chloride	NH <sub>4</sub> Cl
Ammonium sulphate	(NH <sub>4</sub> ) <sub>2</sub> SO <sub>4</sub>
Ammonium sulphate	NH <sub>4</sub> SCN
Amyl acetate	CH <sub>3</sub> COOC <sub>5</sub> H <sub>11</sub>
Amyl alcohol	C <sub>5</sub> H <sub>11</sub> OH
Aniline	C <sub>6</sub> H <sub>5</sub> NH <sub>2</sub>
Animal fat	
Animal fodder	
Arabinose	C <sub>5</sub> H <sub>10</sub> O <sub>5</sub>
Ascorbic acid	C <sub>6</sub> H <sub>8</sub> O <sub>6</sub>
Asparagine	C <sub>4</sub> H <sub>8</sub> O <sub>3</sub> N <sub>2</sub>
Aspartic acid	C <sub>4</sub> H <sub>7</sub> O <sub>4</sub> N
p-Aminoacetophenon	NH <sub>2</sub> .C <sub>6</sub> H <sub>4</sub> .COCH <sub>3</sub>
Baker's yeast	
Barium chloride	BaCl <sub>2</sub>
Barium sulphate	BaSO <sub>4</sub>
Benzaldehyde	C <sub>6</sub> H <sub>5</sub> CHO
Benzene	C <sub>6</sub> H <sub>6</sub>
Benzidine	NH <sub>2</sub> C <sub>6</sub> H <sub>4</sub> .C <sub>6</sub> H <sub>4</sub> NH <sub>2</sub>
Benzoic acid	C <sub>6</sub> H <sub>5</sub> COOH
Biogel	
Blood	
Boric acid	H <sub>3</sub> BO <sub>3</sub>
Butylacetate	CH <sub>3</sub> COOC <sub>4</sub> H <sub>9</sub>
Butyl alcohol	C <sub>4</sub> H <sub>9</sub> OH
Cadmium acetate	Cd(CH <sub>3</sub> COO) <sub>2</sub>
Cadmium sulphate	CdSO <sub>4</sub>
Caffeine	
Calcium carbonate (lime)	CaCO <sub>3</sub>
Calcium chloride	CaCl <sub>2</sub>
Calcium hydroxide	Ca(OH) <sub>2</sub>
Calcium nitrate	Ca(NO <sub>3</sub> ) <sub>2</sub>
Cane sugar	C <sub>12</sub> H <sub>22</sub> O <sub>11</sub>
Carbolic acid	C <sub>6</sub> H <sub>5</sub> O <sub>4</sub>
Carbolic acid - xylene	C <sub>6</sub> H <sub>5</sub> OH-C <sub>6</sub> H <sub>4</sub> (CH <sub>3</sub> ) <sub>2</sub>
Carbon tetrachloride	CCl <sub>4</sub>
Casein	
Castor oil	
Cedarwood oil (concentrated)	
Cement	
Chloral hydrate	CCl <sub>3</sub> CH(OH) <sub>2</sub>
Chlorobenzene	C <sub>6</sub> H <sub>5</sub> Cl
Chloroform	CHCl <sub>3</sub>
Cholesterol	C <sub>27</sub> H <sub>46</sub> OH
Citric acid	C <sub>6</sub> H <sub>8</sub> O <sub>7</sub>
Clay	
Coal	

These elements do not have an impact on the surface area of FunderMax Compact Interior panels, even after prolonged exposure (16 hours).

SUBSTANCE	CHEMICAL FORMULA
Cocaine	C <sub>17</sub> H <sub>21</sub> O <sub>4</sub> N
Coffee	
Common salt	NaCl
Copper sulphate	CuSO <sub>4</sub> .aq
Cosmetics	
Cresol	CH <sub>3</sub> C <sub>6</sub> H <sub>4</sub> OH
Cresylic acid	CH <sub>3</sub> C <sub>6</sub> H <sub>4</sub> COOH
Cyclohexane	C <sub>6</sub> H <sub>12</sub>
Cyclohexanol	C <sub>6</sub> H <sub>11</sub> OH
Detergents	
Dextrose	C <sub>6</sub> H <sub>12</sub> O <sub>6</sub>
Digitonin	C <sub>56</sub> H <sub>92</sub> O <sub>29</sub>
Dimethyl formamide	HCON(CH <sub>3</sub> ) <sub>2</sub>
Dimethyl acetic acid	CH <sub>3</sub> COOH
Dioxan	C <sub>8</sub> H <sub>16</sub> O <sub>2</sub>
Dulcitol	C <sub>6</sub> H <sub>14</sub> O <sub>6</sub>
Ester	RCOOR
Ethanol	C <sub>2</sub> H <sub>5</sub> OH
Ether	ROR
Ethyl acetate	CH <sub>3</sub> COOC <sub>2</sub> H <sub>5</sub>
Ethylene dichloride	CH <sub>2</sub> .CCl
Fodder	
Foodstuffs	
Formaldehyde	HCHO
Formic acid up to 10%	HCOOH
Fructose	C <sub>6</sub> H <sub>12</sub> O <sub>6</sub>
Galactose	C <sub>6</sub> H <sub>12</sub> O <sub>6</sub>
Gelatine	
Glacial acetic acid	CH <sub>3</sub> COOH
Glucose	C <sub>6</sub> H <sub>12</sub> O <sub>6</sub>
Glycerine	CH <sub>2</sub> OH.CHOH.CH <sub>2</sub> OH
Glycocol	NH <sub>2</sub> CH <sub>2</sub> COOH
Glycol	HOCH <sub>2</sub> .CH <sub>2</sub> OH
Graphite	C
Greases	
Gypsum	CaSO <sub>4</sub> .2H <sub>2</sub> O
Heparin	
Heptanol	C <sub>7</sub> H <sub>15</sub> OH
Hexane	C <sub>6</sub> H <sub>14</sub>
Hexanol	C <sub>6</sub> H <sub>13</sub> OH
Hydrogen peroxide 3%	H <sub>2</sub> O <sub>2</sub>
Hypophysin	
Imido „Roche“	
Immersion oil	
Ink	
Inorganic salts and their mixtures	
Inositol	C <sub>6</sub> H <sub>6</sub> (OH) <sub>6</sub>
Insecticides	
Isoamyl acetate	CH <sub>3</sub> COOC <sub>5</sub> H <sub>11</sub>
Isopropanol	C <sub>3</sub> H <sub>7</sub> OH
Ketone	RCOR'
Lactic acid	CH <sub>3</sub> CHOHCOOH
Lactose	C <sub>12</sub> H <sub>22</sub> O <sub>11</sub>
Lead acetate	Pb(CH <sub>3</sub> COO) <sub>2</sub>
Lead nitrate	
Laevoluse	
Lipstick	
Lithium carbonate	

Table 1

**NO DAMAGE**

FunderMax Compact Interior panels are resistant against the following substances and agents.

These substances do not have an impact on the surface area of FunderMax Compact Interior panels, even after prolonged exposure (16 hours).

SUBSTANCE	CHEMICAL FORMULA
Magnesium carbonate	MgCO <sub>3</sub>
Magnesium chloride	MgCl <sub>2</sub>
Magnesium sulphate	MgSO <sub>4</sub>
Maltose	C <sub>12</sub> H <sub>22</sub> O <sub>11</sub>
Manitol	C <sub>6</sub> H <sub>14</sub> O <sub>6</sub>
Mannose	C <sub>6</sub> H <sub>12</sub> O <sub>6</sub>
Mercury	Hg
Mesoinositol	C <sub>6</sub> H <sub>8</sub> (OH) <sub>6</sub>
Methanol	CH <sub>3</sub> OH
Milk	
Mineral oils	
Mineral salts	
Nail varnish	
Nail varnish remover	
α-Naphtol	C <sub>10</sub> H <sub>7</sub> O <sub>7</sub>
α-Naphtylamine	C <sub>10</sub> H <sub>7</sub> NH <sub>2</sub>
Nickel sulphate	NiSO <sub>4</sub>
Nicotine	C <sub>10</sub> H <sub>14</sub> N <sub>2</sub>
p-Nitrophenol	C <sub>6</sub> H <sub>4</sub> NO <sub>2</sub> OH
Nonne-Appelt-reagent	
Octanol	C <sub>8</sub> H <sub>17</sub> OH
n-Octyl alcohol	C <sub>8</sub> H <sub>17</sub> OH
Olive oil	
Oleic acid	CH <sub>3</sub> (CH <sub>2</sub> ) <sub>7</sub> CH:CH(CH <sub>2</sub> ) <sub>7</sub> COOH
Organic solvents	
Ointments	
Pandy's reagent	
Paraffin waxes	C <sub>n</sub> H <sub>2n+2</sub>
Paraffinic oil	
Pentanol	C <sub>5</sub> H <sub>11</sub> OH
Peptone	
Petroleum benzin	
Phenol and phenol derivatives	C <sub>6</sub> H <sub>5</sub> OH
Phenolphthalein	C <sub>20</sub> H <sub>14</sub> O <sub>4</sub>
Polishing agents (creams/waxes)	
Potash lye up to approx. 10%.	KOH
Potassium bromate	KBrO <sub>3</sub>
Potassium bromide	KBr
Potassium carbonate	K <sub>2</sub> CO <sub>3</sub>
Potassium chloride	KCl
Potassium hexacyanoferrate	K <sub>4</sub> Fe(CN) <sub>6</sub>
Potassium iodate	KJO <sub>3</sub>
Potassium nitrate	KNO <sub>3</sub>
Potassium sodium tartrate	KNaC <sub>4</sub> H <sub>4</sub> O <sub>6</sub>
Potassium sulphate	K <sub>2</sub> SO <sub>4</sub>
Potassium tartrate	K <sub>2</sub> C <sub>4</sub> H <sub>4</sub> O <sub>6</sub>
Potato starch	
Propanol	C <sub>3</sub> H <sub>7</sub> OH
1,2-Propylene glycol	CH <sub>3</sub> CHOHCH <sub>2</sub> OH
Pyridine	C <sub>5</sub> H <sub>5</sub> N
Qinol	HOC <sub>6</sub> H <sub>4</sub> OH
Raffinose	C <sub>18</sub> H <sub>32</sub> O <sub>15</sub> .5H <sub>2</sub> O
Rhamnose	C <sub>6</sub> H <sub>12</sub> O <sub>5</sub> .H <sub>2</sub> O
Rochelle salt	
Saccharose	= Cane sugar
Salicylaldehyde	C <sub>7</sub> H <sub>6</sub> OH.CHO
Salicylic acid	C <sub>7</sub> H <sub>6</sub> OHCOOH
Saponon	
Seawater	
Soap	

SUBSTANCE	CHEMICAL FORMULA
Sodium acetate	CH <sub>3</sub> COONa
Sodium carbonate	Na <sub>2</sub> CO <sub>3</sub>
Sodium chloride	NaCl
Sodium citrate	Na <sub>3</sub> C <sub>6</sub> H <sub>5</sub> O <sub>7</sub> .5H <sub>2</sub> O
Sodium diethylene barbiturate	NaC <sub>8</sub> H <sub>11</sub> N <sub>2</sub> O <sub>3</sub>
Sodium hydrogen sulphite	NaHSO <sub>3</sub>
Sodium hydrogencarbonate (Sodium carbonate)	NaHCO <sub>3</sub>
Sodium hydroxide solution (up to approx. 10%)	NaOH
Sodium hyposulphite	Na <sub>2</sub> S <sub>2</sub> O <sub>4</sub>
Sodium nitrate	NaNO <sub>3</sub>
Sodium phosphate	Na <sub>3</sub> PO <sub>4</sub>
Sodium silicate	Na <sub>2</sub> SiO <sub>3</sub>
Sodium sulphate	Na <sub>2</sub> SO <sub>4</sub>
Sodium sulphide	Na <sub>2</sub> S
Sodium sulphite	Na <sub>2</sub> SO <sub>3</sub>
Sodium tartrate	Na <sub>2</sub> C <sub>4</sub> H <sub>4</sub> O <sub>6</sub>
Soil	
Soot	
Sorbitol	C <sub>6</sub> H <sub>14</sub> O <sub>6</sub>
Standard acetate solution	
Standard I + II -Nutrient agar	
Standard I + II -Nutrient broth	
Starch	
Starch -common salt solution	
Stearic acid	C <sub>17</sub> H <sub>35</sub> COOH
Styrene	C <sub>8</sub> H <sub>8</sub> .CH:CH <sub>2</sub>
Sugar and sugar derivates	
Sulphur	S
Talcum powder	3MgO.4SiO <sub>2</sub> .H <sub>2</sub> O
Tannic acid	C <sub>76</sub> H <sub>52</sub> O <sub>46</sub>
Tartaric acid	C <sub>4</sub> H <sub>6</sub> O <sub>6</sub>
Tea	
Test serum for blood grouping	
Tetrahydrofuran	C <sub>4</sub> H <sub>8</sub> O
Tetraline	C <sub>10</sub> H <sub>12</sub>
Thiourea	NH <sub>2</sub> CSNH <sub>2</sub>
Toeffer's reagent	
Toulene	C <sub>6</sub> H <sub>6</sub> CH <sub>3</sub>
Trehalose	C <sub>12</sub> H <sub>22</sub> O <sub>11</sub>
Tricholoro ethylene	CHCl.CCl <sub>2</sub>
Trypsin	
Tryptophane	C <sub>11</sub> H <sub>12</sub> O <sub>2</sub> N <sub>2</sub>
Turpentine	
Tymol	C <sub>10</sub> H <sub>14</sub> O
Tymol buffer solution	
Urea solution	CO(NH <sub>2</sub> ) <sub>2</sub>
Urease	
Uric acid	C <sub>5</sub> H <sub>4</sub> N <sub>4</sub> O <sub>3</sub>
Urine	
Vanillin	C <sub>8</sub> H <sub>8</sub> O <sub>3</sub>
Vaseline	
Water	H <sub>2</sub> O
Water colours	
Xylene	C <sub>6</sub> H <sub>4</sub> (CH <sub>3</sub> ) <sub>2</sub>
Yeasts	
Zinc chloride	ZnCl <sub>2</sub>
Zinc sulphate	ZnSO <sub>4</sub>

Table 1



### NO DAMAGE UNDER SHORT EXPOSURE

Surfaces from FunderMax Compact Interior panels remain unchanged when the following substances are spilt on them (particularly in liquid or dissolved form) or if they are in contact for a short amount of time.

That means the panels are washed with a wet towel within 10-15 minutes and then rubbed dry. Please note that the time of exposure is an important factor in the extent of corrosion on the HPL surfaces, even with diluted agents. As a result of the evaporation of the diluted material, the concentration of the substance increases over a period of time and the surfaces of FunderMax Compact Interior panels will be corroded, even though the concentration used will mostly be below those named in the following list. Focused sample tests are recommended.

SUBSTANCE	CHEMICAL FORMULA
Amino-S acid up to 10%	NH <sub>2</sub> SO <sub>3</sub> H
Aniline dyes	
Antiliming agents	H <sub>3</sub> AsO <sub>4</sub>
Arsenic acid up to 10%	
Boric acid	H <sub>3</sub> BO <sub>3</sub>
Crystal violet (Gentian violet)	C <sub>23</sub> H <sub>28</sub> N <sub>3</sub> Cl
Esbach's reagent	
Formic acid over 10%	
Fuchsine solution	
Hair dyes and bleaches	
Hydrochloric acid up to 10%	HCl
Hydrogen peroxide over 3-30% (Perhydrol)	H <sub>2</sub> O <sub>2</sub>
Inorganic acids up to 10%	
Iodine solution	
Iron (II) chloride solution	FeCl <sub>2</sub>
Iron (III) chloride	FeCl <sub>3</sub>
Mercury (II) chromate	HgCr <sub>2</sub> O <sub>7</sub>
Methylene blue	C <sub>16</sub> H <sub>18</sub> N <sub>3</sub> ClS
Millon's reagent	OHg <sub>2</sub> NH <sub>2</sub> Cl
Nitric acid up to 10%	HNO <sub>3</sub>
Nylander's reagent	
Oxalic acid	COOH.COOH
Phosphoric acid up to 10%	HPO <sub>4</sub>
Picric acid	C <sub>6</sub> H <sub>2</sub> OH(NO <sub>2</sub> ) <sub>3</sub>
Potash lye over 10%	KOH
Potassium hydrogensulphate	KHSO <sub>4</sub>
Potassium chromate	K <sub>2</sub> CrO <sub>4</sub>
Potassium dichromate	K <sub>2</sub> Cr <sub>2</sub> O <sub>7</sub>
Potassium iodide	KJ
Potassium permanganate	KMnO <sub>4</sub>
Silver nitrate	AgNO <sub>3</sub>
Sodium hydrogen-sulphate	NaHSO <sub>4</sub>
Sodium hydroxide sol. over 10%	NaOH
Sodium hypochloride	NaOCl
Sodium thiosulphate	Na <sub>2</sub> S <sub>2</sub> O <sub>3</sub>
Sublimate solution (= mercury (II) chloride)	HgCl <sub>2</sub>
Sulphuric acid up to 10%	H <sub>2</sub> SO <sub>4</sub>
Sulphurous acid up to 10%	H <sub>2</sub> SO <sub>3</sub>
Varnishes and adhesives, (chemically curing)	

Table 2

### HIGH DAMAGE RISK

The following chemicals destroy the FunderMax Compact Interior panel surfaces and must be removed immediately, as they could also leave behind dull spots and coarseness:

SUBSTANCE	CHEMICAL FORMULA
In concentrations greater than 10%:	NH <sub>2</sub> SO <sub>3</sub> H
Amino sulpho acid	
Inorganic acids such as	H <sub>3</sub> AsO <sub>4</sub>
Arsenic acid	
Aqua regia	HNO <sub>3</sub> + HCl = 1:3
Chromosulphuric acid	K <sub>2</sub> Cr <sub>2</sub> O <sub>7</sub> + H <sub>2</sub> SO <sub>4</sub>
Hydrochloric acid	HCl
Hydrofluoric acid	HF
Hydrogen bromide	HBr
Nitric acid	HNO <sub>3</sub>
Phosphoric acid	H <sub>3</sub> PO <sub>4</sub>
Sulphuric acid	H <sub>2</sub> SO <sub>4</sub>

Table 3

### AGGRESSIVE GASES

Frequent exposure to the following aggressive gases and vapours can lead to changes in the FunderMax Compact Interior panel surfaces:

SUBSTANCE	CHEMICAL FORMULA
Acid vapours	
Bromine	Br <sub>2</sub>
Chlorine	Cl <sub>2</sub>
Nitrose fumes	NxOy
Sulphur dioxide	SO <sub>2</sub>

Table 4

## Max Compact Interior Plus

### STERILISABILITY

Thanks to their excellent surface area, Max Compact Interior Plus panels are easy to clean and just as easy to sterilise as for e.g. stainless steel or OP tiles.

### 24-H-CHEMICAL RESISTANCE TEST

DECOR-INDEPENDENT	
Substance	Concentration
<b>All common household solvents</b>	
Nitric acid	10 %
Phosphoric acid	10 %
Acetic acid	10 %
Sodium hypochlorite	13 %
Caustic soda	25 %
Ammonia	25 %

Table 1

## Max Resistance<sup>2</sup> (Lab panels)

With Max Resistance<sup>2</sup> you get tested resistance. Authenticated and award-winning from ofi, the Austrian research Institute for Chemistry and Technology.

### TEST PROCEDURE

The chemical resistance tests were performed in a sefa certified laboratory according to the Test Method: SEFA 3- 2010 Sec 2.1. (24HR EXPOSURE) Detailed information and results are available in the official test reports.

### RESULTS

FunderMax Resistance<sup>2</sup> passed the SEFA 24h Exposure Test and is therefore suitable and recommended for laboratory worktops. Max Resistance<sup>2</sup> exceeds the sefa test criteria by far without one single level 3 rating.

### RATING

#### 0 – No Effect

No detectable change in the material surface.

#### 1 – Excellent

Slight detectable change in color or gloss but no change in function or life of the surface.

#### 2 – Good

A clearly discernible change in color or gloss but no significant impairment of surface life or function.

#### 3 – Fair

Objectionable change in appearance due to discoloration or etch, possibly resulting in deterioration of function over an extended period of time.

### ACCEPTANCE CRITERIA

To be approved as laboratory grade surfaces, tested materials should receive no more than 4 Level 3 ratings.



Substance \ Rating	0	1	2	3
	No effect	Excellent	Good	Fair

**ACIDS**

Acetic acid 99%	●			
Dichromate acid 5% <sup>2)</sup>	●			
Chromic acid 60%	●			
Formic acid 90% <sup>2)</sup>	●			
Hydrochloric acid 37%	●			
Hydro uric acid 48%		●		
Nitric acid 20%	●			
Nitric acid 30%	●			
Nitric acid 70% <sup>2)</sup>			●	
Phosphoric acid 85%	●			
Sulphuric acid 33%	●			
Sulphuric acid 77%	●			
Sulphuric acid 96%		●		
Sulphuric acid 77 % nitric acid 70% (1:1)			●	

**BASES**

Ammonium hydroxide 28%	●			
Sodium hydroxide 10%	●			
Sodium hydroxide 20%	●			
Sodium hydroxide 40%	●			
Sodium hydroxide flake	●			

**SALTS AND HALOGENS**

Saturated Zinc chloride	●			
Saturated silver nitrate	●			
Tincture of iodine <sup>1)</sup>		●		

Table 2



TEST RESULTS MAY DIFFER BY COLOUR

1) RESULT ON 0082

2) RESULT ON 0085

Substance \ Rating	0	1	2	3
	No effect	Excellent	Good	Fair

**ORGANIC CHEMICALS**

Cresol	●			
Dimethylformamide	●			
Formaldehyde 37%	●			
Furfural <sup>1)</sup>		●		
Gasoline	●			
Hydrogen Peroxide 30% <sup>2)</sup>	●			
Hydrogen Peroxide 3%	●			
Phenol 90%		●		
Sodium sulfide saturated	●			

**SOLVENTS**

Acetone <sup>2)</sup>	●			
Amyl Acetate	●			
Benzene	●			
Butyl Alcohol	●			
Carbon Tetrachloride	●			
Chloroform <sup>2)</sup>	●			
Dichlor Acetic Acid <sup>2)</sup>		●		
Dioxane	●			
Diethyl Ether	●			
Ethyl Acetate <sup>1)</sup>	●			
Ethyl Alcohol	●			
Methylalcohol	●			
Methylene Chloride	●			
Methyl Ethyl Ketone	●			
Mono Chlorobenzene	●			
Napthelene	●			
Toluene	●			
Trichloroethyle	●			
Xylene <sup>1)</sup>	●			

Table 3

## Star Favorit

### NO DAMAGE

SUBSTANCE	CHEMICAL FORMULA
Acetone	CH <sub>3</sub> COCH <sub>3</sub>
Active charcoal	
Alcohol	ROH
Alcohol, beverages	
Alcohol, primary	RCH <sub>2</sub> OH
secondary	RR'CHOH
tertiary	RR'R''COH
Aldehyde	RCHO
Alum liquor	KAl(SO <sub>4</sub> ) <sub>2</sub> ·12H <sub>2</sub> O
Aluminium chloride	AlCl <sub>3</sub> .aq.
Aluminium sulphate	Al <sub>2</sub> (SO <sub>4</sub> ) <sub>3</sub>
Amides	RCONH <sub>2</sub>
Amines, primary	RNH <sub>2</sub>
secondary	(RR')NH
tertiary	(RR'R'')N
Ammonium chloride	NH <sub>4</sub> OH
Animal fat	
Benzidine	C <sub>6</sub> H <sub>6</sub>
Butyl alcohol	C <sub>4</sub> H <sub>9</sub> OH
Butylacetate	CH <sub>3</sub> COOC <sub>4</sub> H <sub>9</sub>
Clay	C <sub>6</sub> H <sub>8</sub> O <sub>7</sub>
Coffee	
Cyclohexane	C <sub>6</sub> H <sub>12</sub>
Cyclohexanol	C <sub>6</sub> H <sub>11</sub> OH
Ethanol	C <sub>2</sub> H <sub>5</sub> OH
Ether	ROR'
Ethyl acetate	CH <sub>3</sub> COOC <sub>2</sub> H <sub>5</sub>
Formaldehyde	HCHO
Formic acid up to 10%	HCOOH
Glycerine	CH <sub>2</sub> OH-CHOH-CH <sub>2</sub> OH
Glycol	HOCH <sub>2</sub> -CH <sub>2</sub> OH
Graphite	C
Greases	
Heptanol	C <sub>7</sub> H <sub>15</sub> OH
Hexane	C <sub>6</sub> H <sub>14</sub>
Hexanol	C <sub>6</sub> H <sub>13</sub> OH
Isopropanol	C <sub>3</sub> H <sub>7</sub> OH
Ketone	RR:CO'

SUBSTANCE	CHEMICAL FORMULA
Lactic acid	CH <sub>3</sub> CHOHCOOH
Lipstick	
Methanol	CH <sub>3</sub> OH
Nail polish	
Nail polish remover	
Natriumchlorid	NaCl
n-Octyl alcohol	C <sub>8</sub> H <sub>17</sub> OH
Octanol	C <sub>8</sub> H <sub>17</sub> OH
Oleic acid	CH <sub>3</sub> (CH <sub>2</sub> ) <sub>7</sub> CH=CH(CH <sub>2</sub> ) <sub>7</sub> COOH
Olive oil	
Organic solvents	
Paraffine	C <sub>N</sub> H <sub>2N+2</sub>
Paraffinic oil	
Pentanol	C <sub>5</sub> H <sub>11</sub> OH
Petroleum benzin	
Potash lye up to approx. 10%	KOH
Propanol	C <sub>3</sub> H <sub>7</sub> OH
Soap	
Sodium hydroxide solution (up to approx. 10%)	NaOH
Tartaric acid	C <sub>4</sub> H <sub>6</sub> O <sub>6</sub>
Tea	
Tetrachloride hydrocarbon	CCl <sub>4</sub>
Tinte	
Toulene	C <sub>6</sub> H <sub>5</sub> CH <sub>3</sub>
Turpentine	
Urine	
Water	H <sub>2</sub> O
Water colours	
Xylene	C <sub>6</sub> H <sub>4</sub> (CH <sub>3</sub> ) <sub>2</sub>
Yeasts	

Table 1

### HIGH DAMAGE RISK

The chemicals listed below can destroy the Star Favorit surface and must be removed immediately, as they can leave matt spots even after very short exposure times:

SUBSTANCE	CHEMICAL FORMULA
Amino sulpho acid	NH <sub>2</sub> SO <sub>3</sub> H
Aqua regia	HNO <sub>3</sub> : HCl = 1:3
Arsenic acid	H <sub>3</sub> AsO <sub>4</sub>
Chromosulphuric acid	K <sub>2</sub> CR <sub>2</sub> O <sub>7</sub> + H <sub>2</sub> SO <sub>4</sub>
Hydrochloric acid	HCl
Hydrofluoric acid	HF
Hydrogen bromide	HBr
Nitric acid	HNO <sub>3</sub>
Phosphoric acid	H <sub>3</sub> PO <sub>4</sub>
Sulphuric acid	H <sub>2</sub> SO <sub>4</sub>

Table 2

### AGGRESSIVE GASES

Frequent exposure to the following aggressive gases and vapours can lead to changes in the Star Favorit surfaces:

SUBSTANCE	CHEMICAL FORMULA
Acid vapours	
Aqua regia	HNO <sub>3</sub> +HCL=1:3
Bromine	Br <sub>2</sub>
Chlorine	Cl <sub>2</sub>
Chromosulphuric acid	K <sub>2</sub> CR <sub>2</sub> O <sub>7</sub> +H <sub>2</sub> SO <sub>4</sub>
Hydrofluoric acid	HF
Hydrogen bromide	HBR
Nitrose fumes	NXOY
Sulphur dioxide	SO <sub>2</sub>
Sulphuric acid	H <sub>2</sub> SO <sub>4</sub>

Table 3



**CLEANING RECOMMENDATIONS FOR MAX COMPACT, LAMINATED PANELS, STAR FAVORIT AND STAR FAVORIT SUPERFRONT PANELS**

Please start the cleaning procedure for unknown stains with basic cleaning, cleaning procedure A to G in order to perform the desired success. To prevent streaking you have to perform a final cleaning.



Fig. 1

**BASIC CLEANING**

Clean the surface just with pure hot water and use a soft sponge – (DO NOT use the abrasive "green" side of the sponge), use a soft cloth or a soft brush (e.g. nylon brush).

**CLEANING PROCEDURE A**

Same as basic cleaning, in addition use common household cleaners without abrasives e.g. Dish detergent (Palmolive, Fairy), window cleaner (Ajax, Frosch).

**CLEANING PROCEDURE B**

Same as basic cleaning, but you may additionally use organic solvents (acetone, alcohol, turpentine, thinner). For persistent dirt pollution try to clean mechanically.

**Caution:** avoid scratching, use plastic or wooden spatula.

**CLEANING PROCEDURE C**

If the contamination is not removable, you can use a solution of soft soap - water (1:3). Depending on the degree of pollution leave it on the surface for a couple of minutes. Subsequently do the final cleaning.

**CLEANING PROCEDURE D**

Same as basic cleaning, but you may additionally use commercially available disinfectants. Steam cleaning is possible. Take care of the supporting material (e.g. wood beams, wall paneling, insulation, ...), to avoid wetting.

**CLEANING PROCEDURE E**

Remove immediately! If necessary, perform cleaning procedure C and final cleaning procedure.

**CLEANING PROCEDURE F**

Rub off the surface with a soft cloth or a soft sponge dry. If contaminants cannot be removed, use silicone remover (e.g. Molto).

**CLEANING PROCEDURE G**

Following the initial cleaning, liquid cleaners can be used with polishing chalk (Cif, ATA). Do this procedure only occasionally!

For persistent limescale acidic cleaning agents may be used (for example, 10% acetic acid or citric acid). Subsequently do the final cleaning.

**FINAL CLEANING**

Detergents have to be removed with water completely to avoid streaking. Finally clean with hot water and rub off the surface with an absorbent cloth or paper towel (kitchen roll).

**When cleaning with solvent:**

Observe the accident prevention regulations! Open windows! No open flame!

TYPE OF STAIN	CLEANING PROCEDURE
Adhesives	C
Bacteriological stains	D
Blood	D
Chalk	A
Coal tar (cigarettes)	C
Coffee	A
Colored ballpoint pens	C
Dispersions (Pvac)	C
Dust	A
Emulsions paints	C
Excrement	D
Fingerprints	A
Fitting foam	E
Floor polish	B
Fruit juice	A
Germes	D
Grease fats	A
Grease, oil	A, B, C
Hybrid-glue	E
Limescale	G
Lipstick	C
Marker	C
Marking pen	C
Mordant	C
Paints	C
Pencil	A
Polyurethane foam	E
Rust	G
Sealants (like silicone)	F
Shoe polish	C
Soap residue	A
Spray paint	C
Stamping ink	C
Synthetic resins	E
Tea	A
Two-component adhesive	E
Two-component lacquer	E
Urea-glue	E
Urine	D
Water marks	G
Water-soluble adhesives	A
Water-soluble dyes	A
Wax crayon	C
Wax polish	C
Wax residue	C

Table 4

FunderMax Compact Interior offers a wide variety of design possibilities for both fixed and removable wall, column and ceiling cladding. This model has proven ideal for wall and ceiling cladding in railway stations, airports, subways, entrance areas and covered areas in shopping centers.

On the following pages we will show you a range of wall cladding mounting and application possibilities for FunderMax Compact Interior panels.



## Wall Cladding with Max Compact Interior Panels

### VENTILATED WALL CLADDING

Max Compact Interior with black core is the product of choice for classic ventilated wall cladding. When using the panels, the respective building laws of the country, in particular the respective fire protection requirements for the trade concerned must be reviewed and observed during the installation. The ventilation guarantees a control of temperature and moisture, particularly for existing building moisture in the walls or climatic variations in adjacent rooms.

An unequal climate in front of and behind the materials can lead to warping of the panels. Therefore, the panels have a substructure meaning that a circulation of air (ventilation minimum 20 mm) between the panels and the wall is guaranteed, from top to bottom. Joints between the panels can, if desired, be closed. The expansion room of the panels must not be prevented. It must be ensured that the air supply from below and the extracted air above the panels are free and that the resulting moisture variations will be balanced out by the circulation of air.

Max Compact panels are also available in F-Quality.

### CONSTRUCTION INFORMATION

- An assembly of the wall cladding directly to the wall and the installation of wall elements without substructure and rear ventilation is not allowed.
- The fire protection requirements of the respective country or project must be observed.
- When mounting the panel it must be ensured that the rear ventilation functions properly. Air circulation is only possible if there are areas for air to enter and exit.
- In general, during the construction and fixing process it must be ensured, that the material is not exposed to stagnated water. The panel material must consistently be able to dry.

- Due to the material characteristics, during the bonding of Max Compact panels to one another - edge adhesions or bevels - it must be ensured that all connecting components have been manufactured in the same running direction. That means that they can be joined length to length and breadth to breadth. Therefore, the machine direction must always be indicated on the remaining panels.
- The substructure must be protected against corrosion and rotting.
- Joints or components relating to the panels must be structured in such a way that installations are easily accessible.
- All corners within reach must be bevelled to form V-joints.



Fig. 1



Fig. 1

### Fixing possibilities for wall cladding using FunderMax Compact.

There are different fastening possibilities for wall cladding using FunderMax Compact Interior panels.

FunderMax Compact interior panels can be screwed into a wooden substructure or riveted onto an aluminium substructure.

Furthermore it is possible to fix Max Compact panels with suspension rails from wood or aluminium.

PLEASE CONTACT OUR TECHNICAL SUPPORT.  
WE RESERVE THE RIGHT TO MAKE CHANGES THAT  
EFFECT THE TECHNICAL PROGRESS.



## Visible mechanical fastening

For the use of screws or rivets as fastening devices, the following points must be followed: the centre of the borehole in the substructure must correspond with the centre of the borehole in the FunderMax Compact panels. The mounting devices should be attached from the middle of the panel outwards. A slide point and a maximum of 1 fixed point must be used. Sufficient expansion room must be ensured. In general the joints on the panels should be 2 mm/metre.

### SLIDING POINTS

Depending on the necessary expansion clearance, the drilling diameter for sliding points in the FunderMax Compact panels is bigger than the diameter of the mounting material: the shaft diameter of the fixing device plus at least 2 mm per meter of cladding material from the fixed-point outwards. The head of the fixing device must be big enough to allow the borehole to remain invisible in the FunderMax Compact panels. The fixing device must be arranged in such a way that the panels can move. Rivets are attached with rivet gauges. The defined distance allows a movement of the parts in the borehole (clearance 0.3 mm). Screws should not be fastened too tightly. Do not use counter-head sunk screws, use washers if necessary.

### FIXED POINT

The fixed point allows for the equal distribution (halving) of swelling and hinking movements. The drill diameter in the FunderMax Compact panels is just as big as the diameter of the mounting device.

Per panel, a fixed point is drilled as close to the middle as possible. All other fastening holes are drilled as slide points.

### EDGE SPACINGS

The edge spacings must be maintained for reasons of stability and flatness. In order to allow for dimensional changes, the panel joints must have joints of at least 2 mm per metre of panel.

The stability of cladding is determined by the substructure and the thickness of the cladding material.

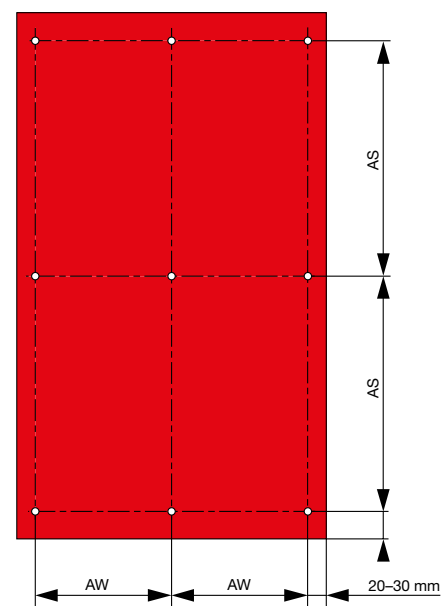

FASTENING DISTANCES

Fig. 2

MAXIMUM FASTENING DISTANCES		
Panel thickness	AS	AW
6 mm	600 mm	470 mm
8 mm	770 mm	620 mm
10 mm	920 mm	770 mm

Table 1

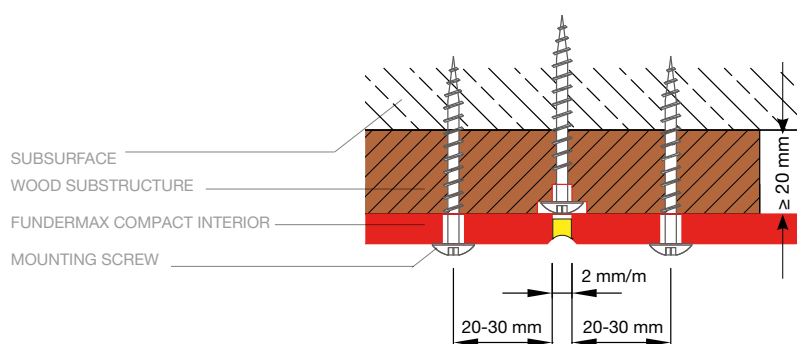

VARIANT WITH REAR VENTILATION AND COMPACT INTERIOR PANELS

Fig. 3

SUPPLIERS OF FASTENERS: SEE PAGE 53



Fig. 1

## Invisible Mechanical Fastenings

If you do not want the mounting fastenings to be visible, then FunderMax Compact Interior panels can also be mounted on the wall with various suspension fastenings.

The profiles which are fastened to the FunderMax Compact Interior panel can be mounted using blind fasteners, screws or spreader or threaded sockets. Ideally, screws or sleeves are used with a metal thread. In both cases, the hole in the Compact panel only needs to be pre-drilled one thread less.

It is important to space the horizontal suspension fastenings in such a way that a vertical rear ventilation is possible.

Furthermore, fixing strips should be slidable or spaced accordingly in order to avoid distortion of the element due to differences in tension.

## Ventilated wall cladding and wall protection with Lohr wall protection profiles

Max Compact panels (thickness  $\geq 10$  mm) are hung using aluminium suspended shackles in the flush mounted aluminium support frame - base and slope profile. The advantages include the low depth of construction and the simple removal.

This profile system is run by the company Helmut Lohr. You can find the address for this company on page 61.





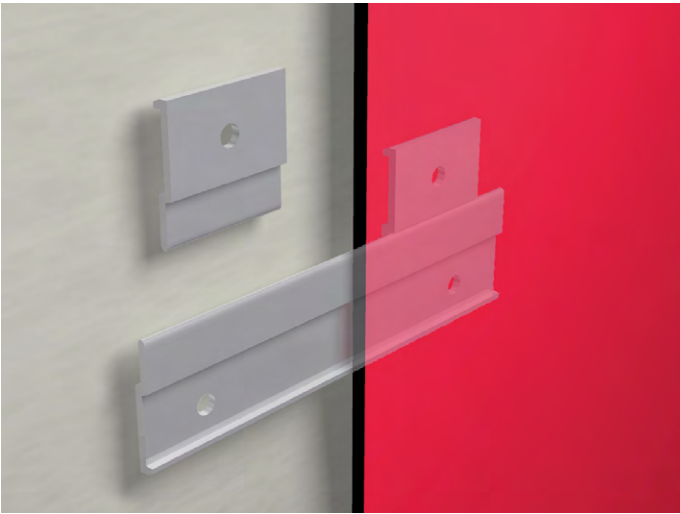
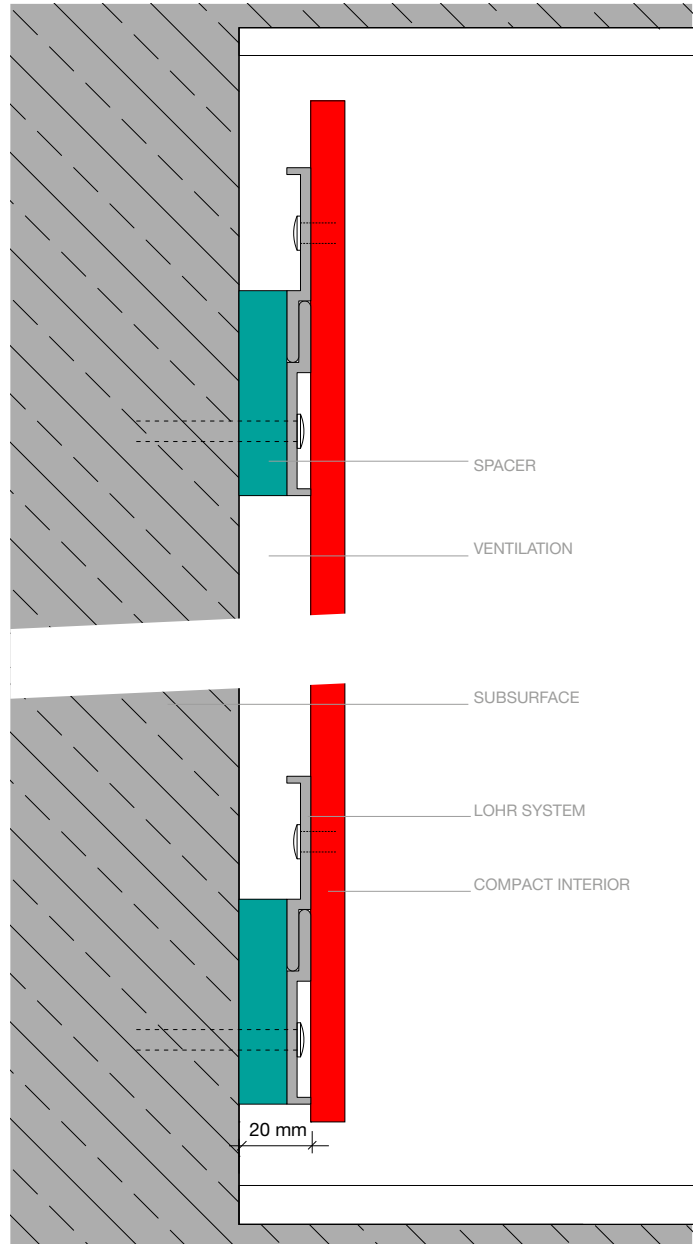

Fig. 2



VERTICAL SECTION VENTILATED WALL CLADDING WITH LOHR WALL PROTECTION BRACKET

Fig. 3

## FunderMax System Wall Protection - Non-ventilated Wall Protection and Floor-to-Ceiling Wall Cladding

The wall protection system offers you

- Possible with all Fundermax Compact Interior und m.look Interior panels.
- A long-lasting, sustainable wall design.
- Flexible, multi-dimensional construction and design options.
- Fulfills European fire protection requirements in accordance with building material classes EN13501-1 B-s1, d0 and A2-S1, d0.
- Can be used in new construction and renovations.
- Lowest component depth.
- Clean connection details to other components.
- Easy installation makes the system ideal for both small and large projects.
- Environmentally friendly: Ökokauf & baubook tested.
- Meets even the strictest hygiene standards.

Due to the rising hygiene requirements in public buildings such as hospitals, retirement and nursing homes, educational buildings, kindergartens, laboratories and clean rooms, escape routes and many other buildings, shopping centers, meeting places, lobbies, offices and entrance areas, it is necessary to mount the wall protection system without ventilation directly on the drywall, concrete or brick wall or by means of a substructure system and metal brackets.

In compliance with the requirements, FunderMax compact panels can be mounted directly on drywall, concrete or brick walls mechanically with visible or invisible mounting brackets.

The wall protection system is available in a wide range of technical and design types. With and without frame profiles.

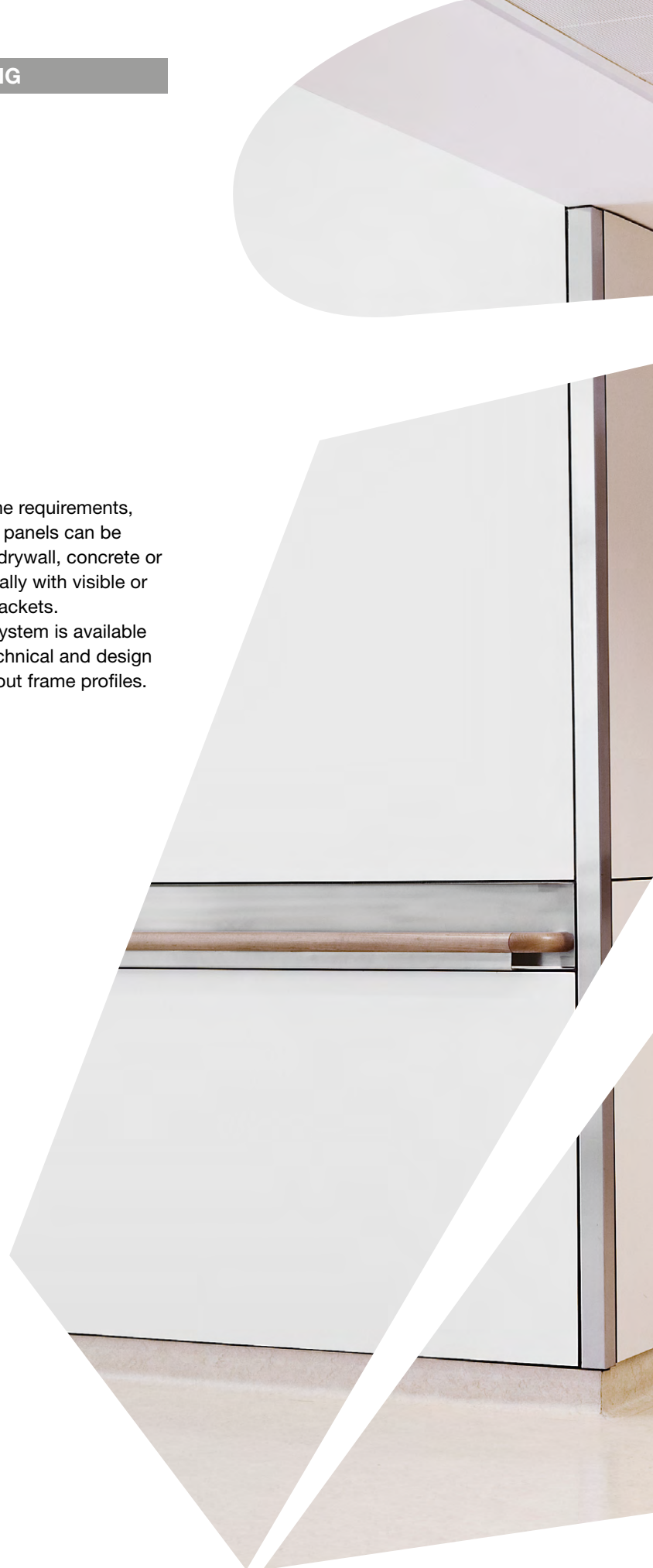

## REQUIREMENTS

**NOTICE:** To ensure the flatness of the wall cladding, the following points must be observed!

- The wall is dry (you are responsible for the measurement, wall moisture 0.4% to max. 1%). Also throughout the installation period before commissioning the object.
- We always recommend applying a vapor-tight, self-adhesive aluminum vapor barrier, model Alujet SE Tape PE, to the subsurface, especially for damp walls.
- The panels are conditioned to the ambient environment.
- The substructure and mounting distances are in accordance with the specifications and system specifications of the respective manufacturer.
- There is at least 5 mm of space between the panel edges and end profiles or door frames
- Since the FunderMax panels react to temperature and humidity fluctuations with an expansion of 2 mm per panel meter, the gaps in the panel joints must be adapted accordingly based on the panel format.
- At the panel joints, the panels are slotted and connected by a metal spring bracket.
- Due to the increased impact load, corner and angled elements should be designed with a metal profile as a system corner element.
- In general, during construction and installation, it should be ensured that the material is not exposed to standing moisture.
- The panel material must always be able to dry. Main source of error and defects in planning and execution.
- The wall protection system should not be placed directly on the floor or, if required structurally, it is necessary to use a wall protection system with a metal base profile.
- If components are connected together, all the components must be manufactured in the same production direction. In other words, only connect horizontal with horizontal and vertical with vertical. Left over panel pieces should therefore always be marked with the production direction.
- The fastening materials must be protected against corrosion.

## TYPES

see Chapter

- A: Wall protection system
- B: Wall protection screwed directly to the wall



Fig. 1

## A: Wall Protection System

An alternative to visibly screwed and glued non-ventilated wall protection is the installation of a mechanically invisible wall protection system.

The wall protection system made of FunderMax Compact panels creates a positive atmosphere in the interior design. The wall protection system allows planners and architects new freedom and can be integrated into any design concept with a wide variety of shapes and colors.

With the wall protection system even the most creative designs can be convincingly implemented. The incredible flexibility of the system is why it can be found in so many public areas.

The wall protection system offers you:

- A durable wall design
- Flexible construction and design options
- Use in new buildings and renovations
- A closed surface and joint
- Clean connection to other building components
- Thanks to its easy installation, the system is suitable for large-scale projects
- ÖkoKauf & baubook tested
- Meets even the strictest hygiene standards
- The hygiene requirements of the respective country or project must be observed.

## APPLICATIONS

Foyers  
Lobbies  
Shopping centers  
Hospitals  
Retirement homes  
Doctor's offices  
Administrative buildings  
Schools  
Assembly rooms etc.

The wall protection system can also be provided in B-s1, d0 and A2, s1-d0 in accordance with EN13501-1.

## WALL PROTECTION SYSTEM SUPPLIERS

### Brem System GmbH

Wandschutz-Handlaufsysteme Werner Brem  
Boschstraße 7  
D-94405 Landau  
Tel.: +49 (0)9951 69030  
Fax: +49 (0)9951 690325  
info@brem-systeme.de  
www.brem-systeme.de

### Duplex GmbH

Pfarrer-Steinberger-Straße 18  
D-944312 Pilsting  
Tel.: +49 (0)9953 9305-0  
Fax: +49 (0)9953 9305-38  
info@system-duplex.com  
www.system-duplex.com

### Röhl

Friedrich-Koenig-Straße 15-17  
D-97297 Waldbüttelbrunn  
Tel.: +49 (0)931 40664-0  
Fax: +49 (0)931 408009  
info@roehl.de

## NOTICE:

PLEASE OBSERVE THE GENERAL REQUIREMENTS FOR A NON-REAR VENTILATED WALL CLADDING ON PAGE 43.



Fig. 2

## B: Direct Screw-Mounted Wall Cladding

### PRODUCT NAMES

Max Compact Interior and  
Max Compact Interior F Quality

#### ■ Properties

Scratch resistant  
Impact resistant  
Solvent resistant  
Easy to clean

#### ■ Building material class

Max Compact Interior  
(EN 13501-1 D-s2,d0)

Max Compact Interior F Quality  
(EN 13501-1 B-s1, d0)

### REQUIREMENTS

- The drill holes are symmetrical, screw spacing 700 mm, distance from edge 50 mm.
- A third row of screws is used for panels with a height of more than 800 mm.
- The hygiene requirements of the respective country or project must be observed.

### INSTALLATION

When installing the panels it is important to start with the outer corners. Afterwards, the individual panels or adjustment panels can be mounted. The panels should be fastened from the middle outwards.

Each panel should have floating points and a maximum of 1 fixed point. (See Fig. 2) Ensure that there is sufficient space to allow for expansion.

In general, the joints between the panels should be  $\geq 2$  mm. Do not use counter-sunk screws to secure the panels! (See Fig. 4, p. 46).

**NOTICE:**  
PLEASE OBSERVE THE GENERAL REQUIREMENTS FOR A NON-REAR VENTILATED WALL CLADDING ON PAGE 43.

## SCREW DISTANCES FOR 6 MM MAX COMPACT

Spacing: 700 mm  
Edge distances: 50 mm

## DRILL HOLE DIAMETER FOR MAX COMPACT

Fixed points: 6.0 mm  
Sliding points: 8.0 mm

The sliding point holes must be completely covered by the screw head!  
Screw head diameter: min. 12 mm

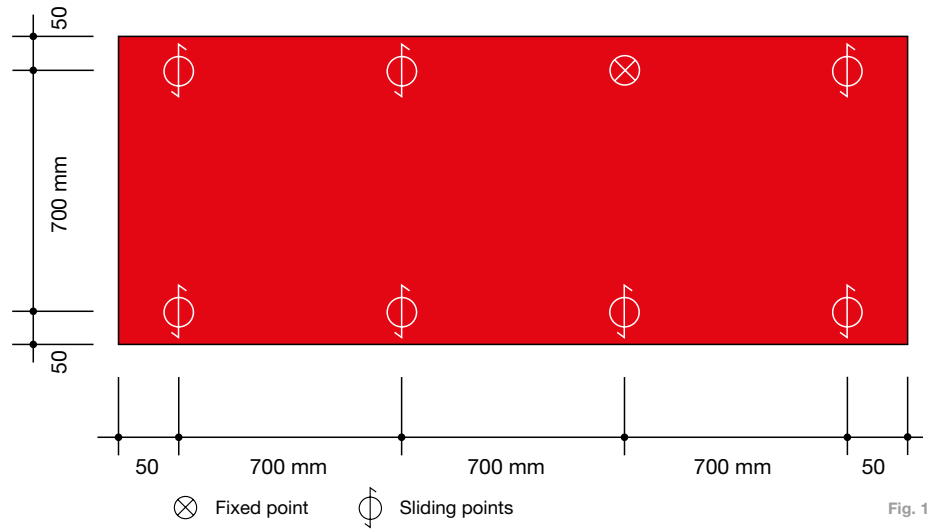

Fig. 1

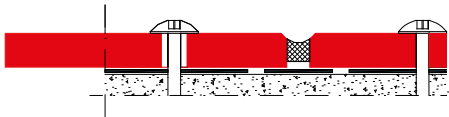

Fig. 2

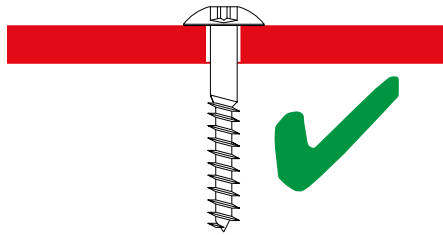

Fig. 3

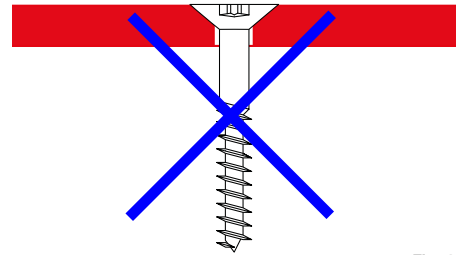

Fig. 4

## Recommended Dowels for Fastening to Drywall

Type	Photo	Dimensions	Load Capacity	Application
HHD-S Hollow-wall Molly Bolt		z.B. M6x38	Shear load: 30 kg	Standard dowel for 95% of the screws
HTB-S Hollow-wall Butterfly Anchor		z.B. M6x60	Shear load: 30 kg	Especially for undefined wall thicknesses
HSP-S Self-drilling Drywall Anchor		z.B. M6x38	Shear load: 7 kg	Especially for special or corner solutions

Table 1

**BOTTOM EDGE OPTIONS**

In order to ensure the exact alignment of the elements, we recommend using an end profile.

This type of wall cladding is mainly used in areas with higher hygiene demands, therefore special attention should be paid to creating precise joints.

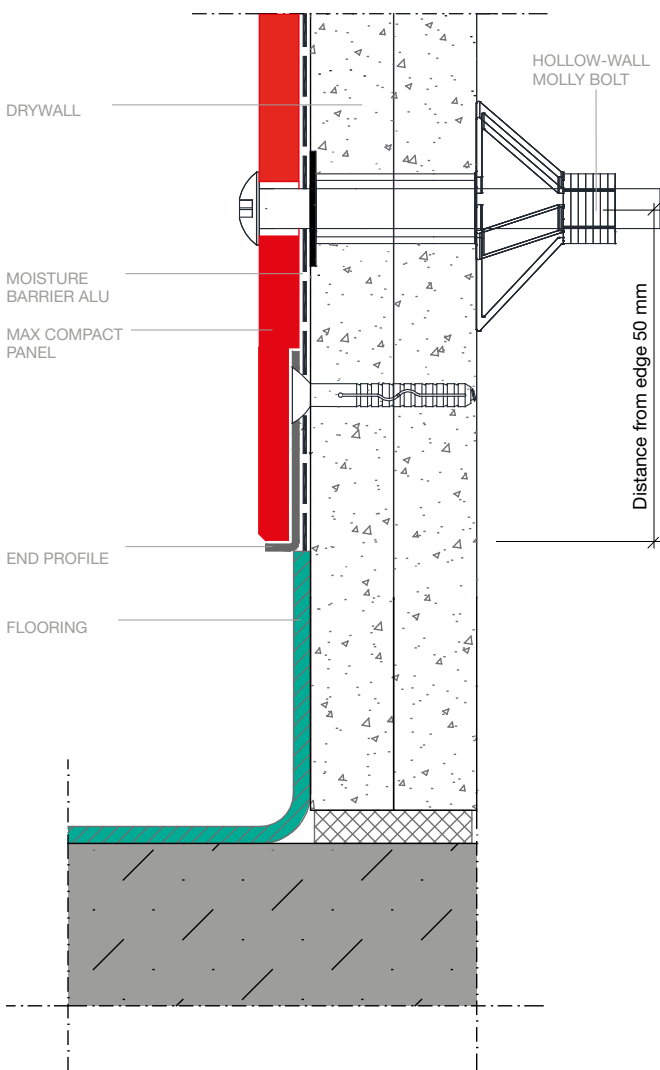

VERTICAL SECTION IMPACT PROTECTION – BOTTOM EDGE WITH PVC FLOORING

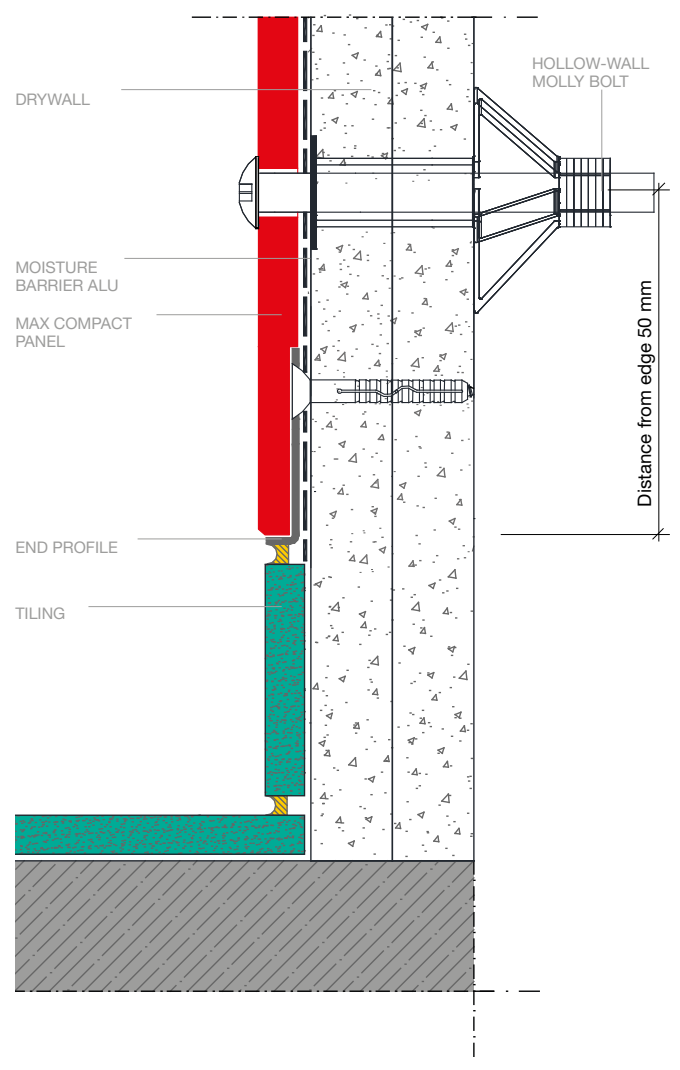

Fig. 5 VERTICAL SECTION IMPACT PROTECTION – BOTTOM EDGE FLUSH WITH TILE

Fig. 6

## SIDE EDGE DETAILS

In order to ensure an exact edge, we recommend using an end profile.

This type of wall cladding is mainly used in areas with higher hygiene demands, therefore special attention should be paid to creating precise joints.

The joint between door frames or end profiles must be at least 5 mm.

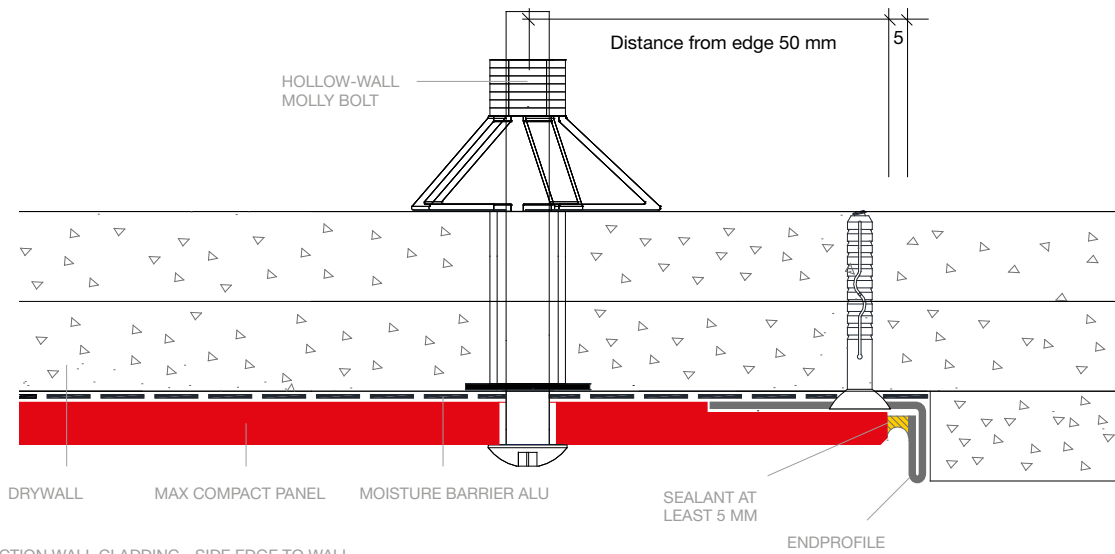

HORIZONTAL SECTION WALL CLADDING - SIDE EDGE TO WALL

Fig. 1

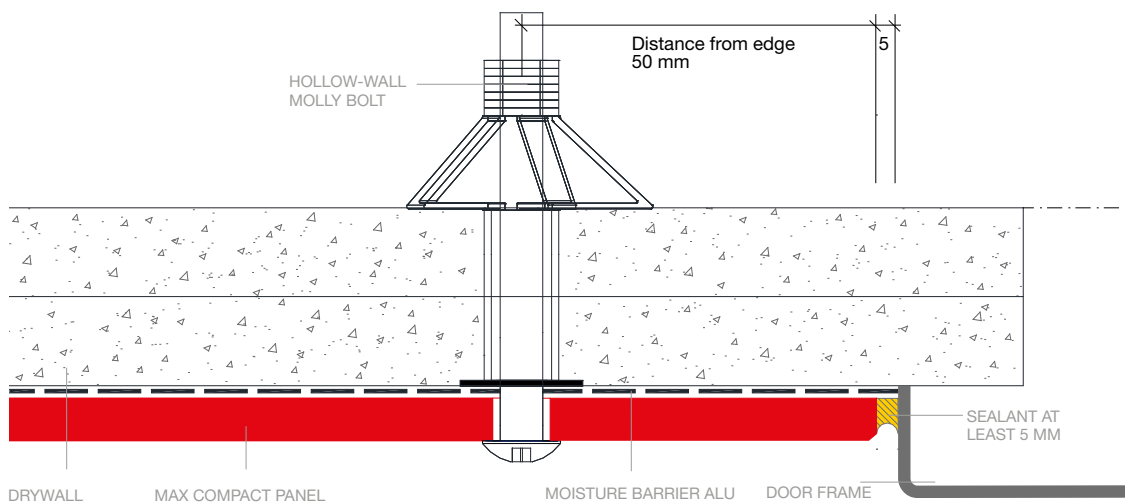

HORIZONTAL SECTION WALL CLADDING - SIDE EDGE TO DOOR FRAME

Fig. 2



**SQUARE CORNERS**

In order to ensure an exact edge, we recommend using an end profile.

Only one row of centrally placed screws can be used for panel strips of up to 100 mm in corner areas.

This type of wall cladding is mainly used in areas with higher hygiene demands, therefore special attention should be paid to creating precise joints.

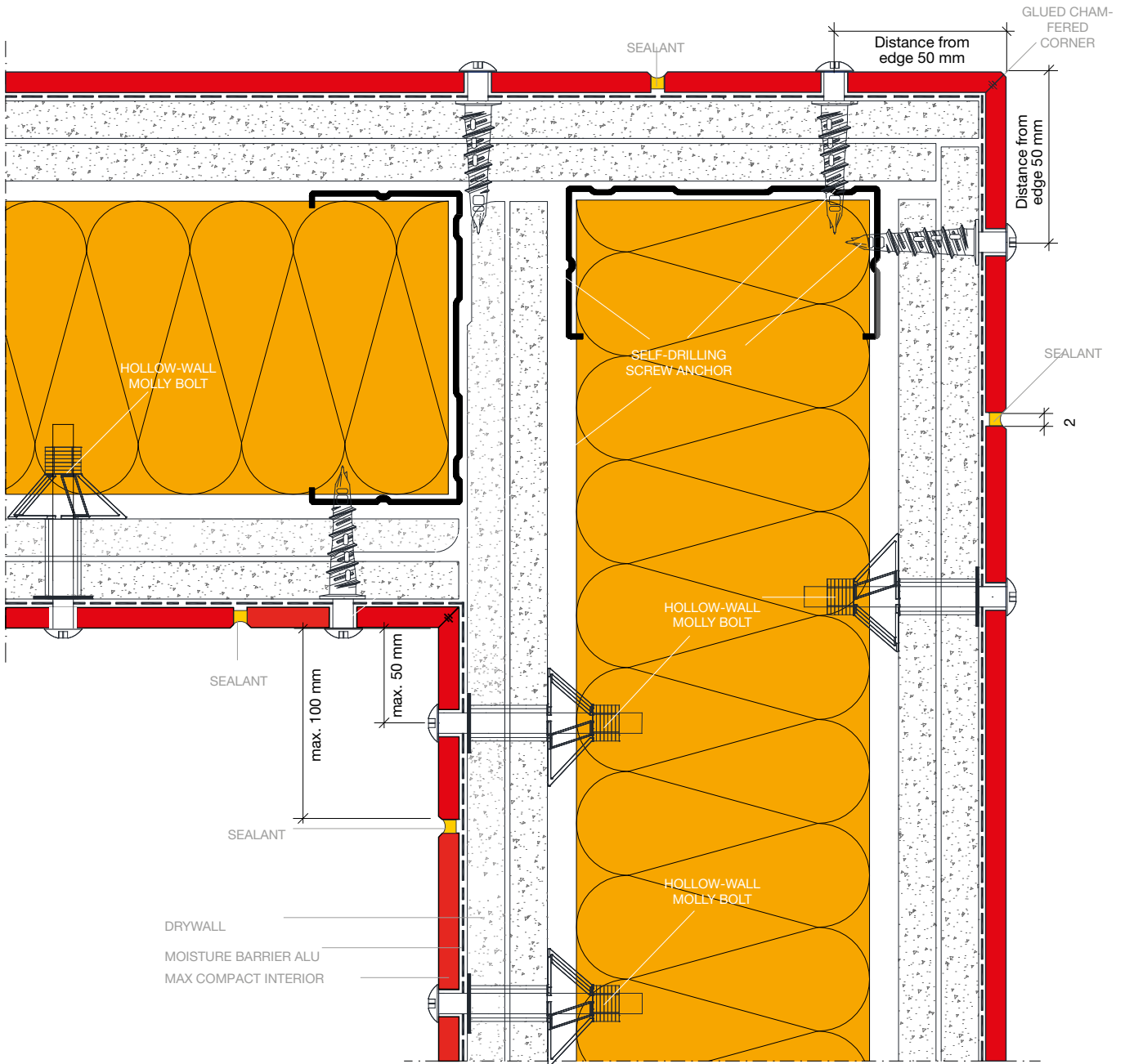

HORIZONTAL SECTION CORNER DESIGN - CHAMFERED JOINT FOR INNER AND OUTER CORNERS

Fig. 3

**BOTTOM EDGE OPTIONS**

In order to ensure an exact edge, we recommend using an end profile.

This type of wall cladding is mainly used in areas with higher hygiene demands, therefore special attention should be paid to creating precise joints.

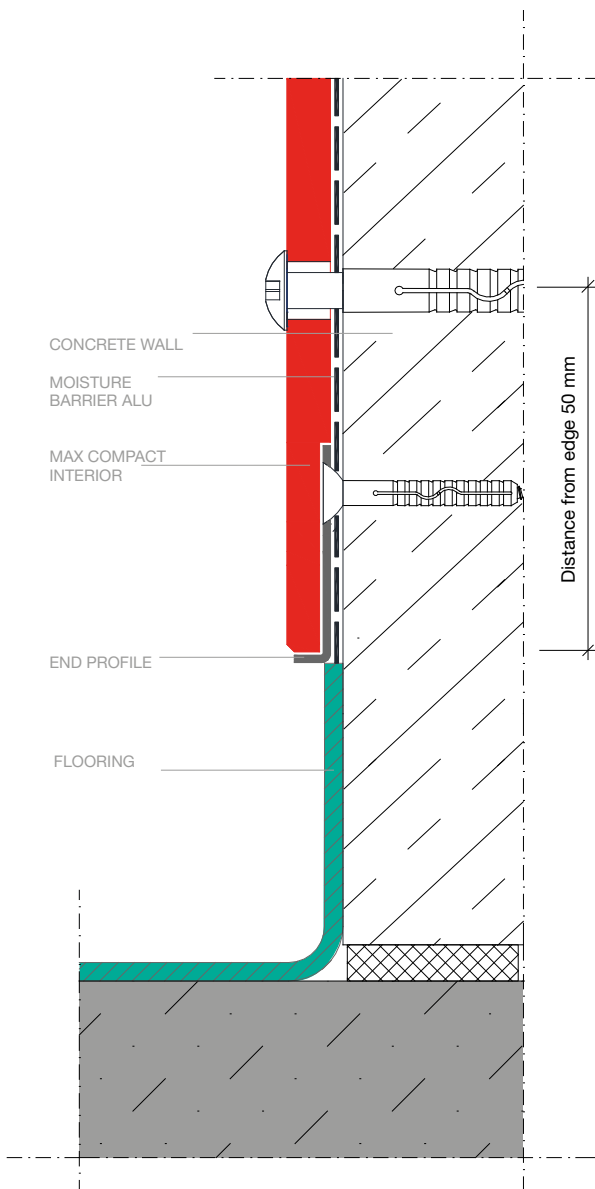

VERTICAL SECTION IMPACT PROTECTION – BOTTOM EDGE WITH PVC FLOORING

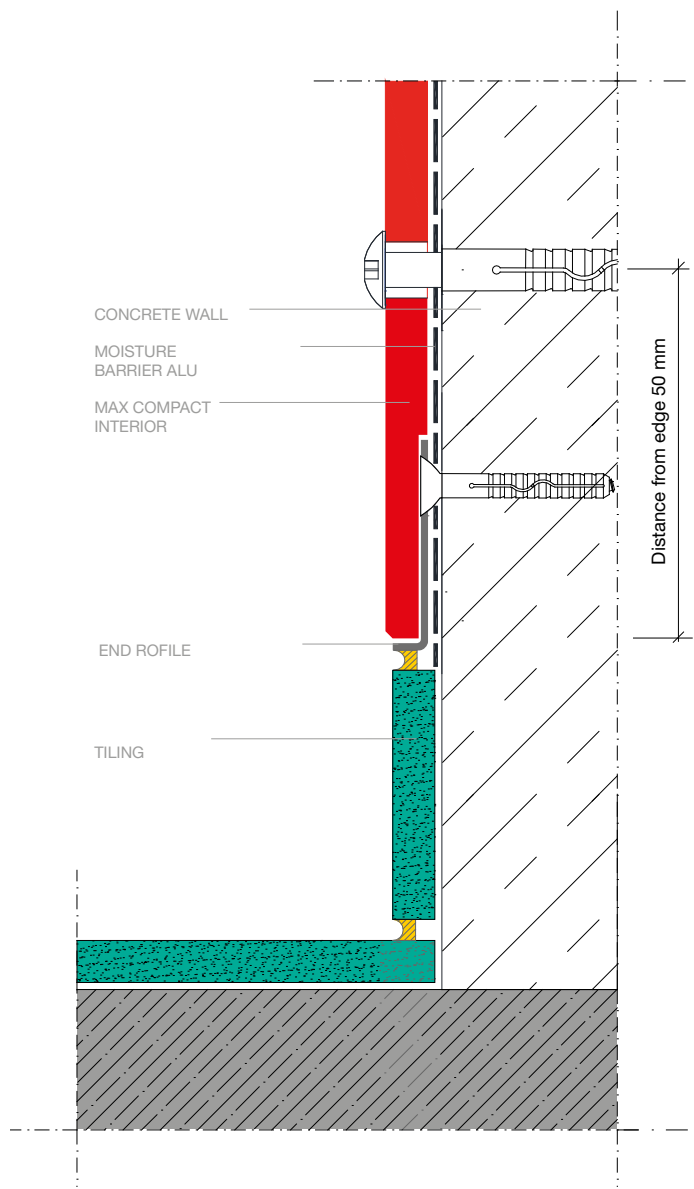

Fig. 1 VERTICAL SECTION IMPACT PROTECTION – BOTTOM EDGE FLUSH WITH TILES

Fig. 2

**SIDE EDGE DETAILS**

In order to ensure an exact edge, we recommend using an end profile.

This type of wall cladding is mainly used in areas with higher hygiene demands, therefore special attention should be paid to creating precise joints.

The joint between door frames or end profiles must be at least 5 mm.

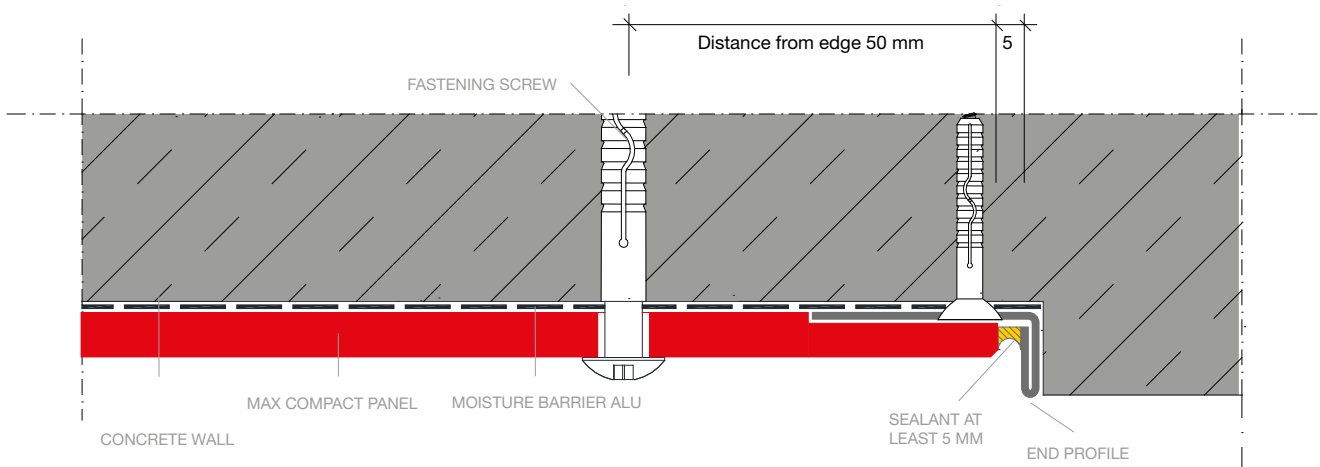

HORIZONTAL SECTION WALL CLADDING - SIDE EDGE TO WALL

Fig. 3

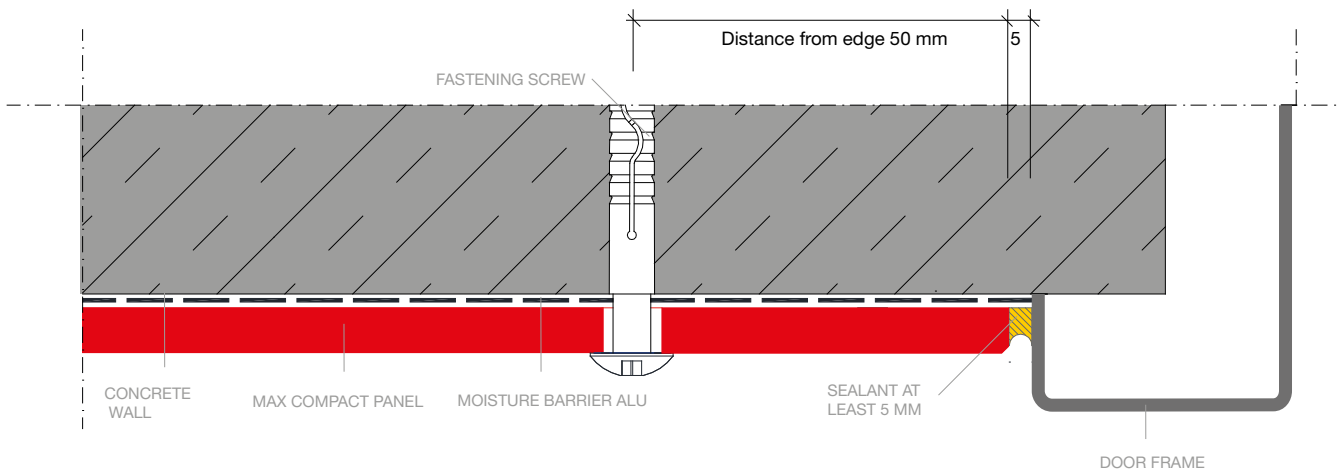

HORIZONTAL SECTION WALL CLADDING - SIDE EDGE TO DOOR FRAME

Fig. 4

## SQUARE CORNERS

It is absolutely necessary to observe the edge distance of 50 mm in order to ensure stability and flatness.

In order to accommodate dimensional changes, the joints between the panels must be  $\geq 2$  mm. Only one row of centrally placed screws can be used for panel strips of up to 100 mm in corner areas.

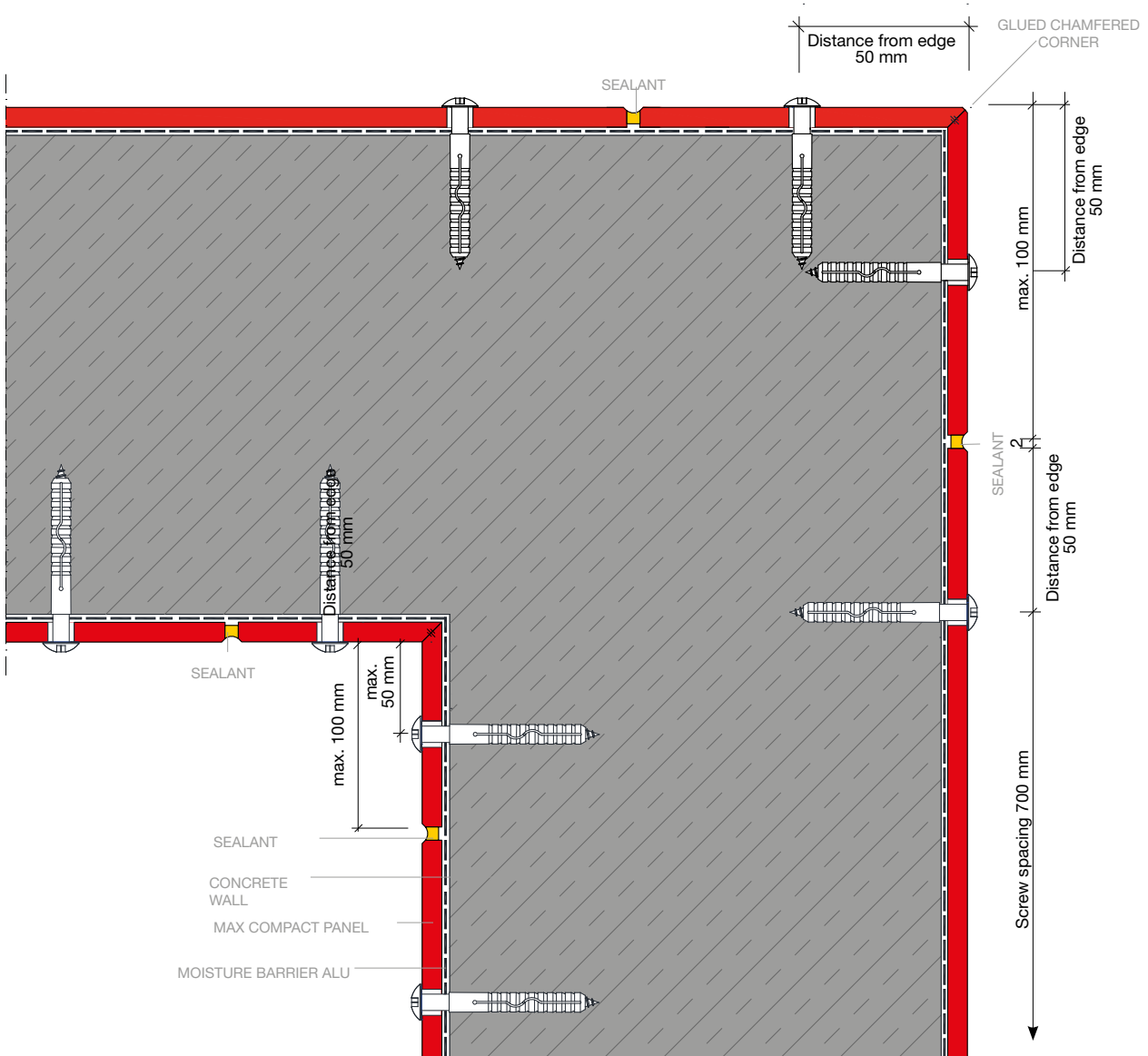

Fig. 1

**FASTENINGS  
(MECHANICAL)****Austria**

EJOT AUSTRIA GmbH  
Grazer Vorstadt 146  
A-8570 Voitsberg  
Tel.: +43 3142 / 276 00-0  
Fax: +43 3142 / 276 00-30  
info@ejot.at, www.ejot.at

SFS Intec GmbH  
Wienerstraße 29  
A-2100 Korneuburg  
Tel.: +43 (0)2262 / 90500 102  
Fax: +43 (0)2262 / 90500 930  
www.sfsintec.biz

Hilti Austria Ges.m.b.H.  
Altmannsdorferstrasse 165  
A-1230 Wien  
Tel. 0800 - 81 81 00  
Fax 0800 - 20 19 90  
Email: HiltiAustria@hilti.com

Fischer Austria GmbH  
Wiener Straße 95  
A-2514 Traiskirchen  
Tel.: +43 (0) 2252 53730-0  
Fax: +43 (0) 2252 53730-70  
www.fischer.at

**Germany**

MBE GmbH  
Siemensstraße 1  
D-58706 Menden  
Tel.: +49 (0)2373 17430 - 0  
Fax: +49 (0)2373 17430 - 11  
www.mbe-gmbh.de

Fischerwerke  
Arthur Fischer GmbH&CoKG  
Weinhalde 14-18  
D-72178 Waldachtal/Tuurlingen  
Tel.: +49 (0)7443 / 120  
Fax: +49 (0)7743 / 1242 22  
www.fischer.de

**Netherlands**

Ipex Europe B. V.  
Vonderweg 14  
NL-7468 DC ENTER  
Tel.: +31 547 384 635  
Fax: +31 547 384 637  
www.ipex-group.com

**Switzerland**

SFS intec AG (Headquarters)  
Rosenbergsaustasse 10  
CH-9435 Heerbrugg  
Tel.: +41 71 / 727 62 62  
Fax: +41 71 / 727 53 07  
gmi.heerbrugg@sfsintec.biz  
www.sfsintec.biz

**PROFILES/ACCESORIES****Austria**

Protektor Bauprofile GmbH  
Hirschstettnerstr. 19/Bauteil IS/ZI 318  
A-1220 Wien  
Tel.: +43 (0)1 / 259 45 00-0  
Fax: +43 (0)1 / 259 45 00-19  
www.protektor.com/at/

Fa. Helmut Lohr  
Elisabethstraße 36  
A-2380 Perchtoldsdorf  
Tel.: +43 (0)669 / 11506880  
Fax: +43 (0)1 / 867 48 29  
E-Mail: info@lohrshop.com

**Germany**

Protektorwerk  
Florenz Maisch GmbH & Co.KG  
Viktoriastraße 58  
D-72571 Gaggenau  
Tel.: +49 (0)7225 / 977-0  
Fax: +49 (0)7225 / 977-111  
info@protektor.com  
www.protektor.com

**France**

PROTEKTOR S.A. BATI-PROFIL  
Rue Pasteur Prolongée  
F-94400 Vitry sur Seine  
Tel.: +33 (0)1 / 55 53 17 50  
Fax: +33 (0)1 / 55 53 17 40

**CORRECTORS (PAINTS)****Austria**

VOTTELER Lacktechnik GmbH  
Malvenstraße 7  
A-4600 Wels  
Tel.: +43 (0)7242 / 759-0  
Fax: +43 (0)7242 / 759-113  
at.info@votteler.com  
www.votteler.com

**Germany**

Heinrich König & Co. KG  
An der Rosenhelle 5  
D-61138 Niederdorfelden  
Tel.: +49 (0)6101 / 53 60-0  
Fax: +49 (0)6101 / 53 60-11  
info@heinrich-koenig.de  
www.heinrich-koenig.de

FSG Schäfer GmbH  
Boschstraße 14  
D-48703 Stadtlohn  
Tel.: +49 (0)2563 / 9395-0  
Fax: +49 (0)2563 / 9395-25  
verkauf@fsg-schaefer.de  
www.fsg-schaefer.de

## Cubicles

Due to their water-resistance, and hygienic surfaces, FunderMax Compact Interior panels are particularly suitable for use in wet rooms, shower screens, therapy rooms and changing rooms.

Using these panels, architects and builders can ensure that the environmental and functional requirements are fully met.



Fig. 1

### TECHNICAL NOTE ON THE USE OF FUNDERMAX COMPACT INTERIOR PANELS

- Throughout the construction and mounting process it is particularly important to ensure that the material is not exposed to stagnated moisture. The panel material must always be able to dry out. For shower facilities which will be exposed to prolonged use, a sufficient ventilation system in the room is important.
  - Due to the material characteristics, it must thoroughly be ensured that during the adhesion process of FunderMax Compact Interior panels to one another (doubling, corner joints or bevelling), all bonded parts have the same fibre direction. This means that attachments should be made solely length to length and breadth to breadth. The remaining panels must always be indicated with the production direction. Corner joints must be mechanically supported through the use of dowels, springs, special milling procedures etc.
  - When designing shower cubicles, care must be taken that the door element made of Max Compact Interior is not directly exposed to contact with water. Shower cubicles should therefore be made with an anteroom, such as a shower stall with a changing area divided by a curtain, to avoid curling of the door leaf.
  - For high levels of moisture e.g. shower cubicles or similar, a mechanical connection of joints is indispensable when combined with an elastic and watertight bonding adhesive system.
- For the construction of cubicles from FunderMax Compact Interior panels, you have the possibility to choose from our extensive range of colours from the FunderMax Range of decors. Please consult our current valid delivery programme. The construction elements described in this brochure, compact interior technique, are suitable for all areas of use of FunderMax Compact Interior panels.

If other profiles, fixtures etc. are used, these must be provided in stainless steel quality if used in wet or damp rooms (nirosta, brass, aluminium).

We reserve the right to make changes that affect the technical progress.

## Construction examples for Changing Rooms and Restroom Stalls

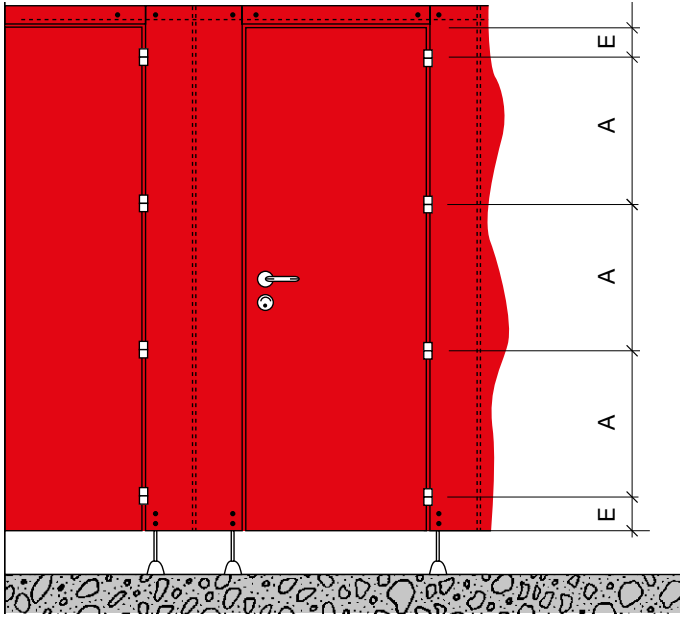

CUBICLES WITH SEPARATING WALL SUPPORTS

Fig. 2a

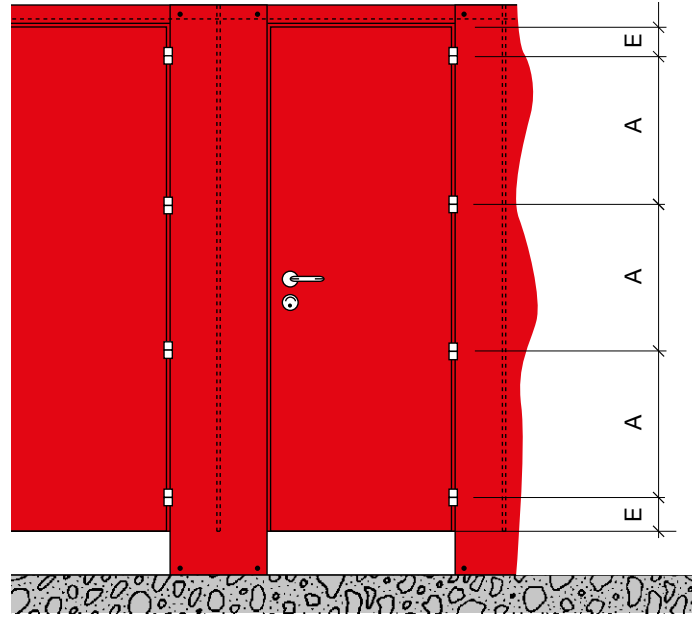

CUBICLES WITH SHIELD ON THE FRONT SIDE

Fig. 3a

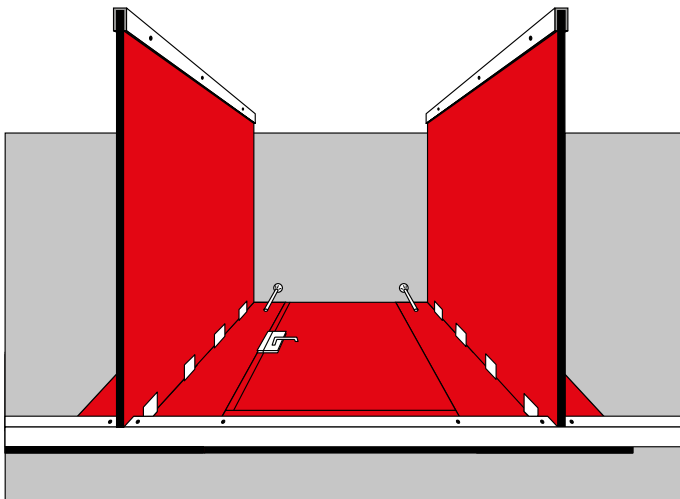

Fig. 2b

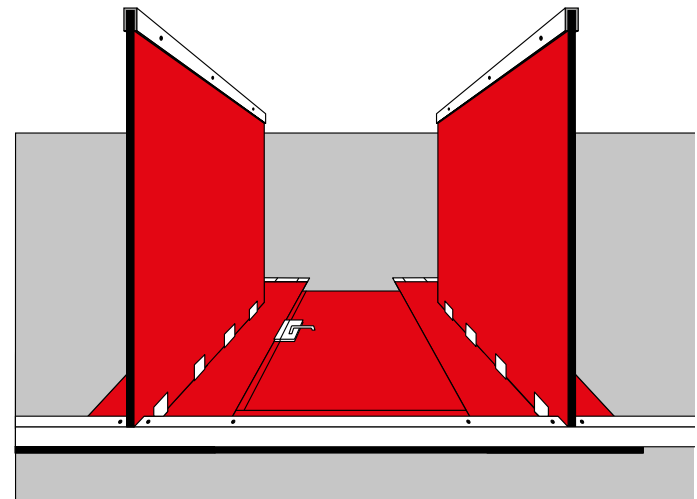

Fig. 3b

The construction examples on the following pages merely show a few possibilities for cubicle construction. Requirements may vary depending on construction and fittings. As regards the panel thickness however, it is recommended that FunderMax Compact Interior panels with thickness of 13 mm be used under all circumstances.

The following mounting distances apply for door hinge distances as well as the mechanical attachment of the Max Compact Interior panel to the wall and the Max Compact Interior panels to each other:

Panel thickness in mm	max A in mm	E in mm
13	600	20 - 100

Table 1

Construction Example  
Changing Rooms and Restroom Stalls

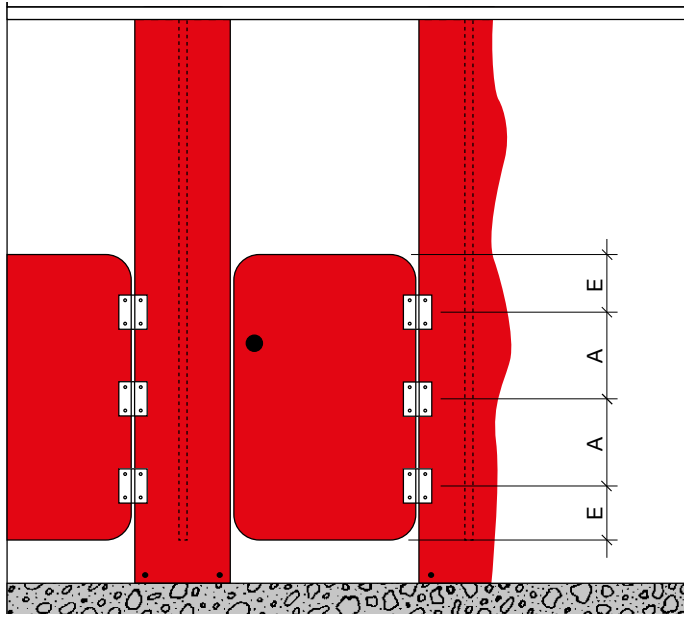

CUBICLES WITH CLOSING DOORS (SPRING HINGES)  
FOR SHOWERS OR NURSERY SCHOOL TOILETS

Fig. 1a

Construction Example  
Shower Divider

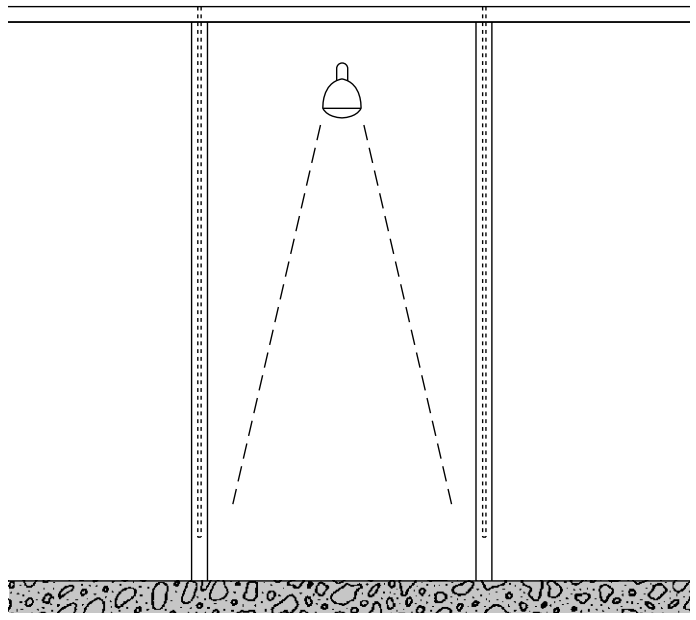

SHOWER DIVIDER WITH UPRIGHTS AND LINTEL PROFILE  
MADE FROM FORMING TUBE

Fig. 2a

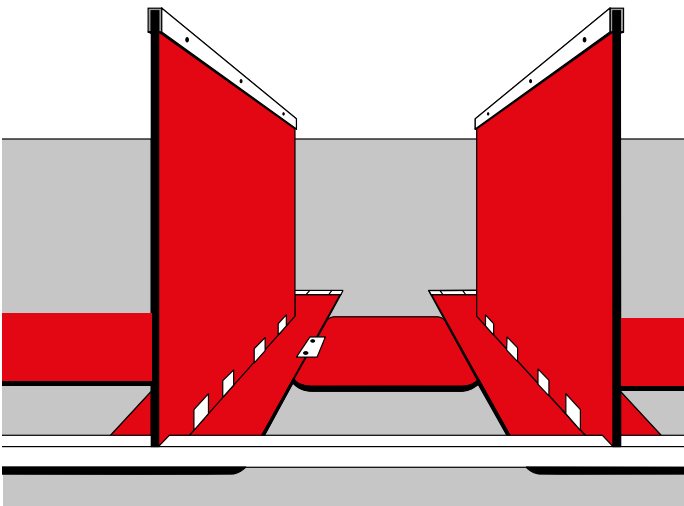

Fig. 1b

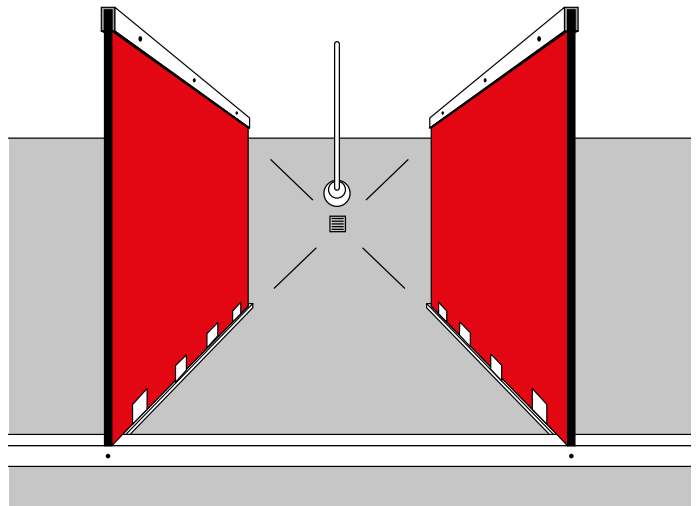

Fig. 2b



## Construction details

### FLOOR CONNECTIONS

In order to balance out uneven ground surfaces, but also to protect the FunderMax Compact Interior panels from a build-up-of water, foot supports from various suppliers are used (see suppliers/accessories for cubicles p. 61).

#### ■ Wall separating supports

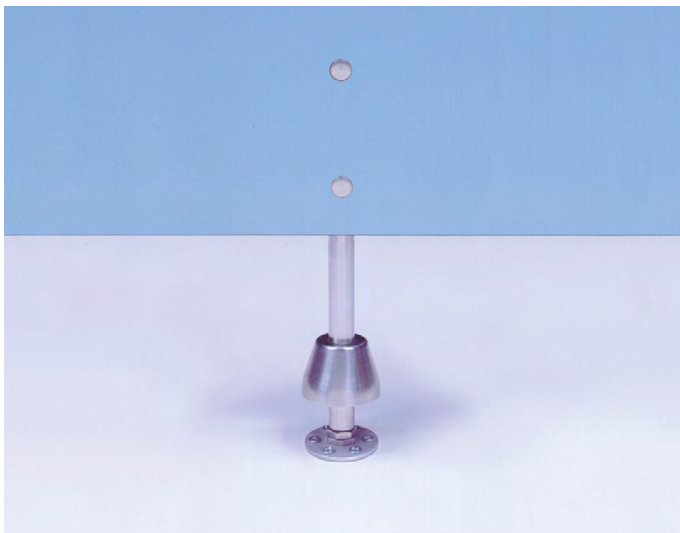

SUPPORTS WITH HEIGHT ADJUSTMENT, EXTERIOR VIEW

Fig. 3

#### ■ Wall separating supports with in-built height adjustment



HEIGHT ADJUSTMENT IN-BUILT SUPPORTS, EXTERIOR VIEW

Fig. 4



SUPPORTS WITH HEIGHT ADJUSTMENT, INTERIOR VIEW

Fig. 5

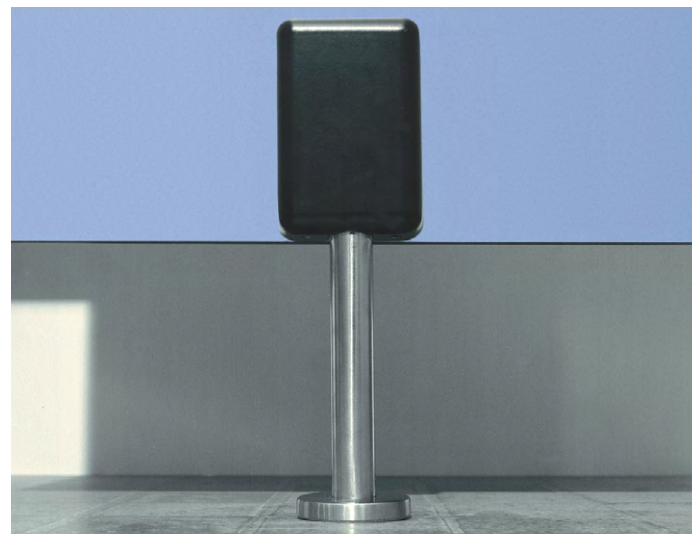

HEIGHT-ADJUSTABLE IN-BUILT SUPPORTS, INTERIOR VIEW

Fig. 6

Construction details

FLOOR CONNECTIONS

- L-profile natural anodised aluminium

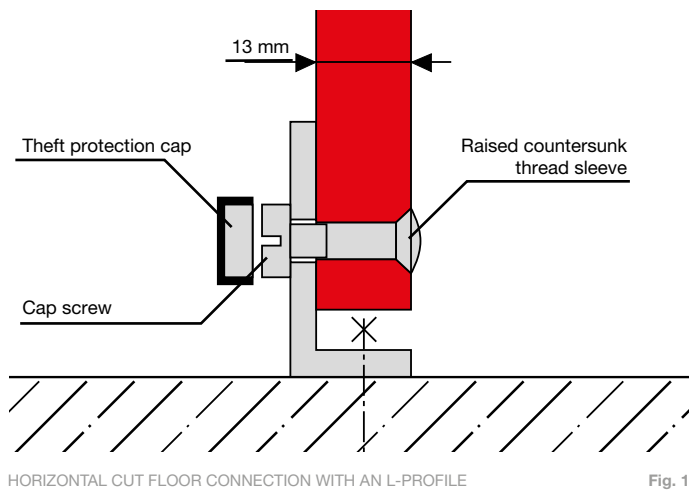

Fig. 1



FLOOR CONNECTION WITH L-PROFILE

Fig. 2

- Floor connection for frontal uprights (for shower and screen walls) and cubicles

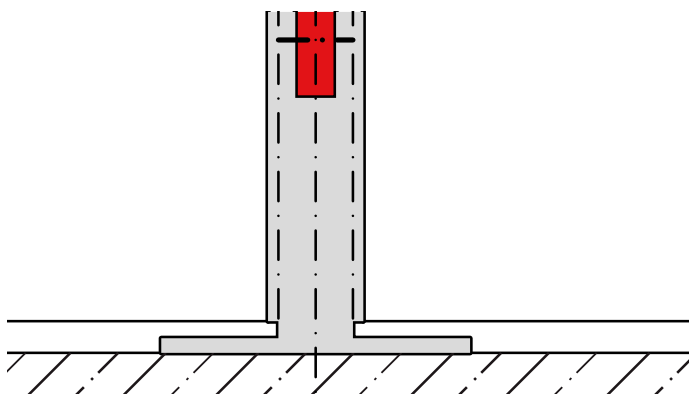

Fig. 3

Construction details

CONNECTIONS OF SEPARATING AGENTS

For attaching FunderMax Compact Interior panels to the wall aluminium, stainless steel or plastic brackets can be used.

- Stainless steel wall connecting component with 2 black end caps



Fig. 4

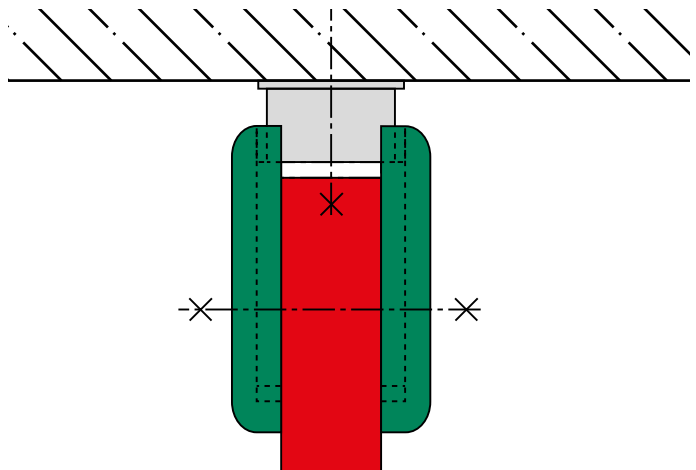
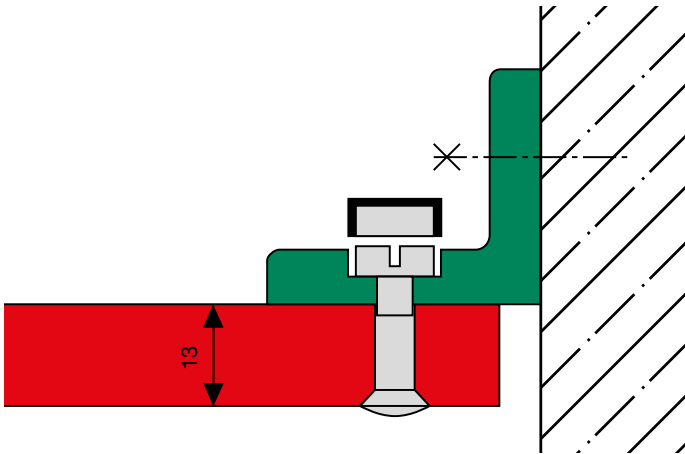

Fig. 5

- Wall separating connection brackets made from plastic for the connection of the front components, to the outside walls.



HORIZONTAL SECTION

Fig. 6

**WALL CONNECTIONS**

- U-profile anodised aluminium for a connection of the separating screens to the wall for 13 mm FunderMax Compact Interior panels

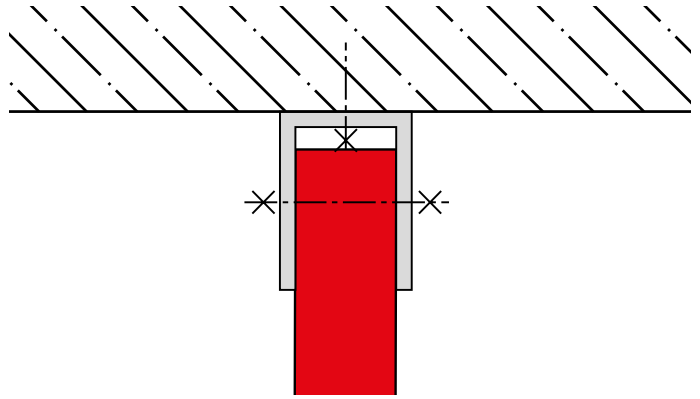

HORIZONTAL SECTION

Fig. 8

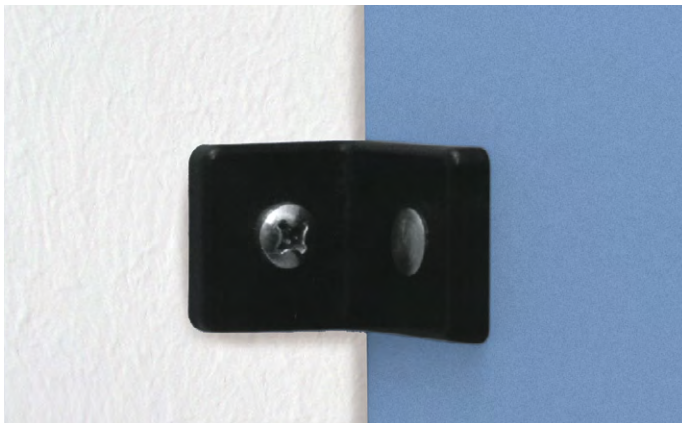
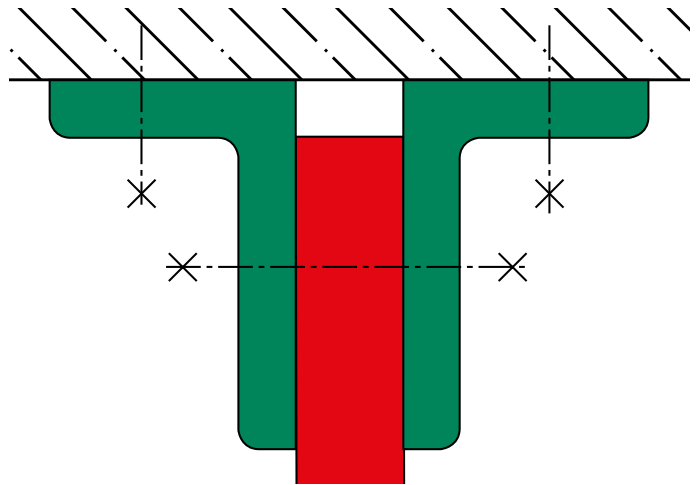

Fig. 7

- 2 separating wall end brackets made from plastic with 13 mm lights for FunderMax Compact Interior panels



HORIZONTAL SECTION

Fig. 9

Large expansion area  $\leq 12$  mm, meaning that a lateral adjustment is largely unnecessary. Access is however, not possible.

Construction details

**WALL CONNECTIONS**

■ Trax-coupling for the connection of the separating walls to the front screens with 2 black cover plates for 13 mm thick panels.

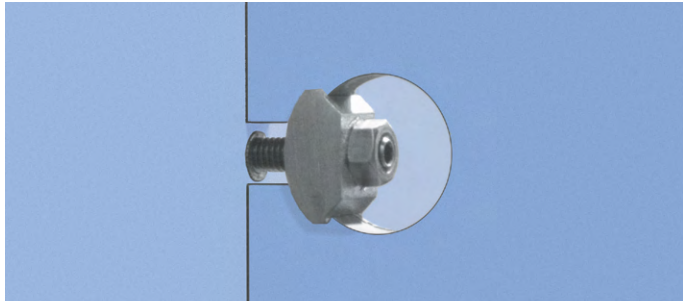

TRAX-COUPLING OPEN

Fig. 1



Fig. 2

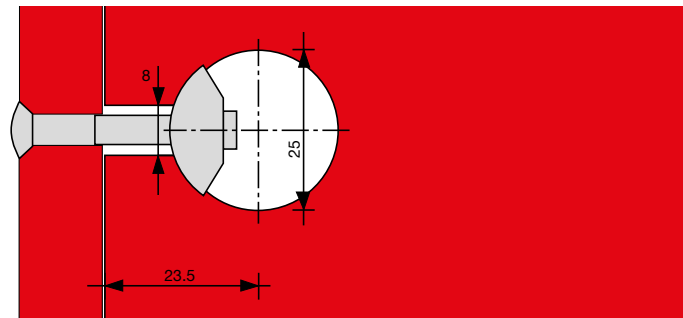

SIDE-VIEW OF THE COUPLING DRILLING

Fig. 3



CONNECTION OF THE SEPARATING WALL TO THE UPRIGHT FRAME

Fig. 4

**DOOR SUPPORT PROFILES AND LINTEL PROFILES**

■ Lintel profile

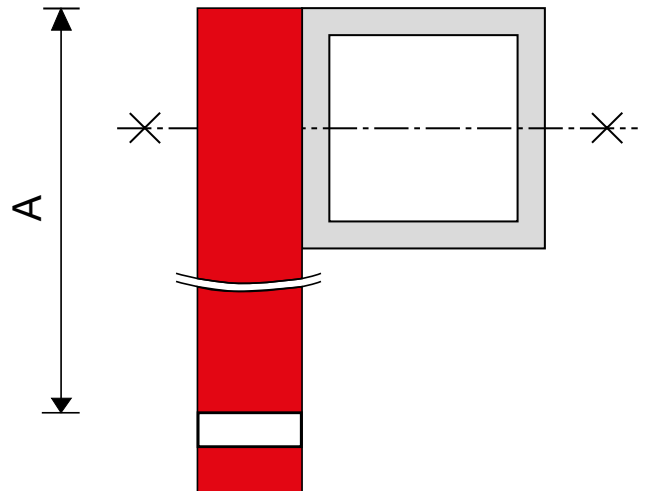

VERTICAL SECTION OF THE LINTEL PROFILE ABOVE

Fig. 5



Fig. 6



SUPPORT AREA FOR INWARDS OPENING DOORS A MINIMUM OF 80 MM HIGH, IN ORDER TO BE ABLE TO HANG THE DOOR, DIMENSION A.

Fig. 7



## Construction details

### PANEL CONNECTIONS

For the connection of FunderMax Compact Interior panels, a separating wall panel thickness of 13 mm

#### Couplings for panel connections

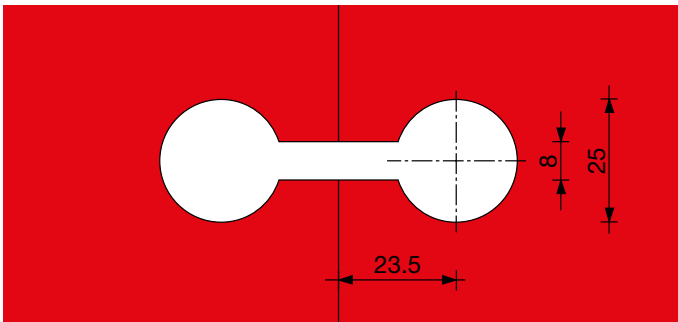

VIEW OF MILLING OUT FOR COUPLING

Fig. 8

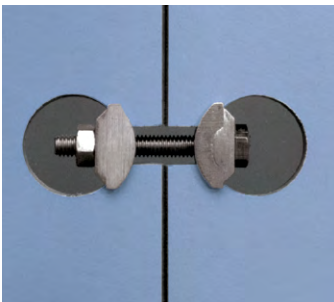

STRAINING SCREW

Fig. 9



Fig. 10

#### Over-panelling

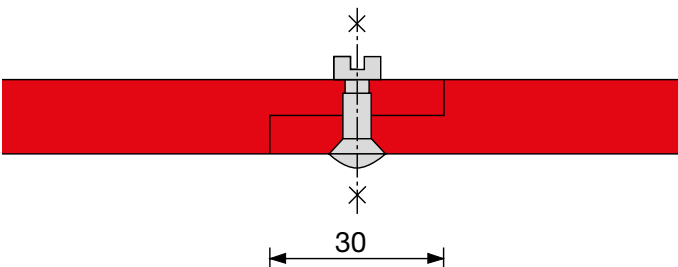

HORIZONTAL SECTION - OVER - PANELLING

Fig. 11

The over-panelling must be at least 30 mm wide, glued with pur glue and 3 to 4 screws in addition.

For walls wider than 1300 mm, a stiffening profile and a support must be provided.

## Suppliers/accessories for cubicles

### CONSTRUCTION ELEMENTS

Schäfer Bädertechnik  
Moselstr. 61  
D-42579 Heiligenhaus  
Tel.: +49 (0)2054 / 938 46 66  
Fax: +49 (0)2054 / 938 46 67  
schaefer@baedertechnik.com  
www.baedertechnik.com

Normbau GmbH  
Schwarzwaldstr. 15  
D-77871 Renchen  
Tel.: +49 (0)7843 / 704-0  
Fax: +49 (0)7843 / 704-43  
info@normbau.de  
www.normbau.de

PBA s.r.l.  
Via Enrico Fermi 1  
I-36056 Tezze Sul Brenta (VI)  
Tel.: +39 0424 / 54 51  
Fax: +39 0424 / 545 222  
info@pba.it  
www.pba.it

PBA Deutschland  
Raiffeisen Str. 4a  
D-83607 Holzkirchen  
Tel.: +49 (0)8024 / 60 84 694  
Fax: +49 (0)8024 / 47 49 890  
info@de.pba.it  
www.corona-hv.de/pba.htm

Fa. Helmut Lohr  
Elisabethstraße 36  
A-2380 Perchtoldsdorf  
Tel.: +43 (0)669 / 11506880  
Fax: +43 (0)1 867 48 29  
info@lohrshop.com

### FITTING PARTS

HEWI Heinrich Wilke GmbH  
Postfach 1260  
D-34442 Bad Arolsen  
Telefon: +49 (0)5691 / 82-0  
Telefax: +49 (0)5691 / 82-319  
info@hewi.de  
www.hewi.de

GM Zargenprofil Topglas  
Glas Merte GmbH & Co KG  
Brachsenweg 39  
A- 6900 Bregenz  
Te.: +43 (0)5574 / 67 22-0

### CORRECTORS (PAINTS)

VOTTELER Lacktechnik GmbH  
Malvenstraße 7  
A-4600 Wels  
Tel.: +43 (0)7242 / 759-0  
Fax: +43 (0)7242 / 759-113  
at.info@votteler.com  
www.votteler.com

Heinrich König & Co. KG  
An der Rosenhelle 5  
D-61138 Niederdorfelden  
Tel.: +49 (0)6101 / 53 60-0  
Fax: +49 (0)6101 / 53 60-11  
info@heinrich-koenig.de  
www.heinrich-koenig.de

FSG Schäfer GmbH  
Boschstraße 14  
D-48703 Stadthorn  
Tel.: +49 (0)2563 / 9395-0  
Fax: +49 (0)2563 / 9395-25  
verkauf@fsg-schaefer.de  
www.fsg-schaefer.de

### SEVERAL ACCESSORIES

Schachermayer  
Großhandels-gesellschaft mbH  
Schachermayerstr. 2-10  
A-4021 Linz  
Tel.: +43 (0)732 / 6599 - 0  
Fax: +43 (0)732 / 6599 - 1360  
zentrale@schachermayer.at  
www.schachermayer.at

Hueck + Richter Aluminium GmbH  
Rossakgasse 8  
A-1230 Wien  
Tel.: +43 (0)1 / 667 15 29-0  
Fax: +43 (0)1 / 667 15 29-0  
www.hueck.at

Pauli + Sohn GmbH  
Eisenstraße 2  
D-51545 Waldbröl  
Tel.: +49 (0)2291 / 9206-0  
Fax: +49 (0)2291 / 9206-681  
www.pauli.de

SWS Ges. f. Glasbaubeschläge  
Friedrich-Engels-Straße 12  
Tel.: +49 (0)2291 / 7905-0  
Fax: +49 (0)2291 / 7905-10  
D-51545 Waldbröl  
info@sws-gmbh.de  
www.sws-gmbh.de

Lauterbach GmbH  
Heraeusstraße 22  
D-06803 Bitterfeld-Wolfen/OT Greppin  
Tel.: +49 (0)3493 / 82 76 76  
Fax: +49 (0)3493 / 92 29 06  
info@lauterbach-gmbh.com  
www.lauterbach-gmbh.com



Fig. 1

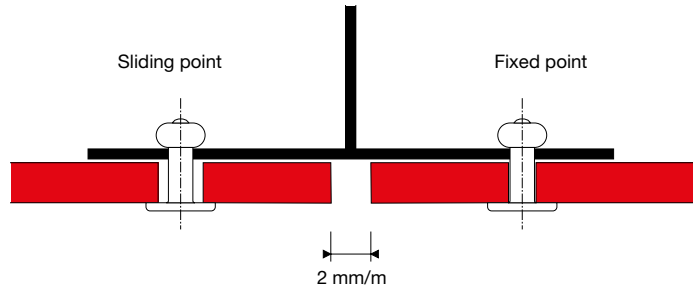

Fig. 2

## Visible mechanical fastening with rivets or screws

FunderMax Compact Interior panels can be mounted on an aluminium substructure using rivets or on a wooden substructure using screws. Due to the material characteristics of Max Compact Interior, fixed and slide points must be drilled for the mounting process.

### VENTILATION

As with wall cladding, sufficient ventilation must also be ensured when processing ceiling panels and cladding. (See chapter on wall cladding).

### SLIDING POINT

The diameter of the drill hole in FunderMax Compact must be drilled larger than the diameter of the fastening, depending on the required expansion clearance. This is the shaft diameter of the fastening plus 2 mm for every meter of cladding material starting from the fixed point.

The head of the fastening must be big enough so that the drill hole in Max Compact is always covered. The fastening is placed in such a way that the panel can move. The rivets must be put in place with a flexible mouthpiece. The defined distance allows a movement of the parts in the borehole (clearance 0.3 mm).

Screws must not be over-tightened. Do not use any countersunk screws. Use washers, if necessary.

### FIXED POINT

The fixed point allows for the equal distribution (halving) of swelling and shrinking movements. The drill diameter in the FunderMax Compact panels should be the same size as the diameter of the mounting device.

Per panel, a fixed point is drilled as close to the middle as possible. All other fastening holes are drilled as slide points.

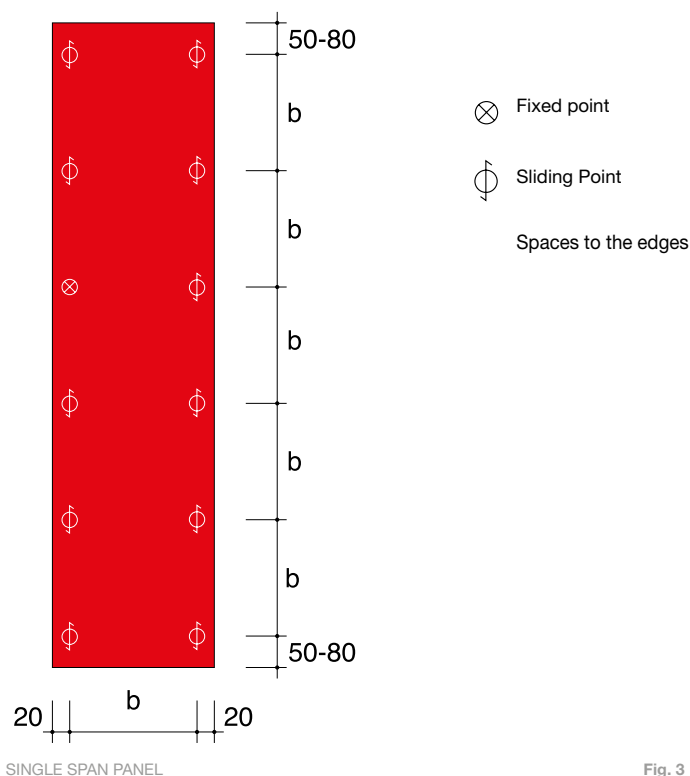

SINGLE SPAN PANEL

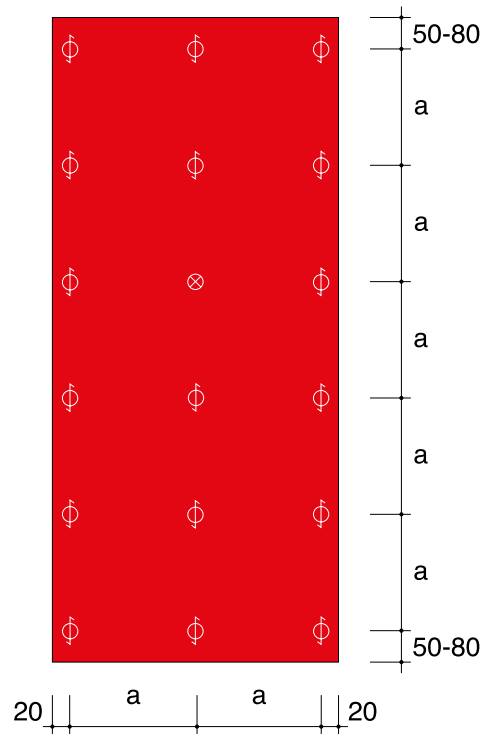

DOUBLE SPAN PANEL

Fig. 4

**FOR INSTALLATION WITH MECHANICAL FASTENINGS**

Panel thickness	maximum fastening spacing „b“ single span panel	maximum fastening spacing „a“ double span panel
6 mm	350 mm	400 mm
8 mm	400 mm	450 mm
10 mm	450 mm	500 mm

Table 1

**EDGE SPACINGS**

For reasons of stability and flatness, the edge spacings must be kept to without fail. The joints must be made at least 2 mm/m wide so that changes in size can take place without hindrance (fig. 2).

**FASTENING SPACINGS**

These are to be chosen in accordance with the structural engineering requirements (calculations) or, if this is not necessary due to the local regulations, according to table 1.

Suppliers of fastening you will find on page 65 or at our Website [www.fundermax.at](http://www.fundermax.at)

**FASTENINGS**

It is essential that only fastening materials made from noncorroding materials can be used.

**Max Compact installation screw** with Torx 20 stainless steel X5Cr Ni Mo 17122 material No. 1.4401 V4A. Painted head available upon request. Drill diameter in Max Compact for installation with screw.

Sliding points: 8 mm or as required.  
Fixed point: 6 mm

**Alu-Blind rivet with big head** colour lacquered or with covering cap for wall claddings with FunderMax Compact panels on aluminium-substructures.

Rivet sleeve: EN AW-5019 acc. DIN EN 755-2  
Rivet pin: steel material-no. 1.4541  
Pull-off strength of rivet pin: ≤ 5.6 kn  
lacquered head on request.

Diameter of drill hole in Max Compact for installation with rivets

Sliding points: 8.5 mm or as required  
Fixed points: 5.1 mm

Diameter of drill hole in Max Compact for installation with rivets sliding points: 8.5 mm or as required fixed points: 5.1 mm. The rivets must be put in place with a flexible mouthpiece, clearance 0.3 mm. The rivet, flexible mouthpiece and riveting tool must be suited to each other.



Fig. 1

## Secret fastening with adhesive system

FunderMax Compact Interior panels can be attached to aluminium substructures using adhesive systems. The stability of the structure must be tested using static objects.

It is important that the respective construction supervisory body on a local or national level grants authorisation. Due to the different regional building regulations (building codes), the construction supervisory board can demand for additional support structures by means of mechanical fixings (rivets, screws etc.). The adhesion must be carried out following the processing regulations from the adhesive system manufacturer.

FunderMax recommends using adhesive systems which are also approved by the building authorities for the mounting of curtain-type ventilated facades.

The following listed points must be considered throughout the working process:

### Pretreatment of aluminium substructures

- Sanding with abrasive fleece
- Pretreatment with cleaning product provided by the adhesive manufacturer
- Application of the primer following the recommendations of the adhesive manufacturer

### Pretreatment of FunderMax Compact panels

- Sanding with abrasive fleece
- Pretreatment using the cleaning product provided by the adhesive manufacturer
- Application of the primer following the recommendations of the adhesive manufacturer. All adhesive surfaces must remain clean, dry and grease-free. Throughout the construction process it must be ensured that the adhesive system is not exposed to any stagnated moisture.



## Suppliers/accessories for ceilings and ceiling cladding

### FASTENINGS (MECHANICAL)

#### Austria

EJOT AUSTRIA GmbH  
Grazer Vorstadt 146  
A-8570 Voitsberg  
Tel.: +43 3142 / 276 00-0  
Fax: +43 3142 / 276 00-30  
info@ejot.at, www.ejot.at

SFS Intec GmbH  
Wienerstraße 29  
A-2100 Korneuburg  
Tel.: +43 (0)2262 / 90500 102  
Fax: +43 (0)2262 / 90500 930  
www.sfsintec.biz

#### Germany

MBE GmbH  
Siemensstraße 1  
D-58706 Menden  
Tel.: +49 (0)2373 17430 – 0  
Fax: +49 (0)2373 17430 – 11  
www.mbe-gmbh.de

Fischerwerke  
Arthur Fischer GmbH&CoKG  
Weinhalde 14-18  
D-72178 Waldachtal/Tuurlingen  
Tel.: +49 (0)7443 / 120  
Fax: +49 (0)7443 / 1242 22  
www.fischer.de

#### Netherlands

Ipex Europe B. V.  
Vonderweg 14  
NL-7468 DC ENTER  
Tel.: +31 547 384 635  
Fax: +31 547 384 637  
www.ipex-group.com

#### Switzerland

SFS intec AG (Headquarters)  
Rosenbergsaustrasse 10  
CH-9435 Heerbrugg  
Tel.: +41 71 / 727 62 62  
Fax: +41 71 / 727 53 07  
gmi.heerbrugg@sfsintec.biz  
www.sfsintec.biz

### FASTENINGS (GLUEING):

#### Austria

Fassadenklebetechnik Klug GmbH  
Zentrale  
Julius-Tandler-Platz 6/15  
A-1090 Wien  
Tel.: +43 (0)676 / 727 1724  
r.klug@fassadenklebetechnik.at  
office@fassadenklebetechnik.at  
www.fassadenklebetechnik.at

INNOTEK Industries VertriebsgmbH  
Boden 35  
A-6322 Kirchbichl  
Tel.: +43 (0) 5332 / 71138  
Fax: +43 (0) 5332 / 72891  
www.innotec.at

PROPART Handels GmbH  
Lauchenholz 28  
A-9122 St. Kanzian am Klopeinersee  
Tel.: +43 (0) 4239 40 300  
Fax: +43 (0) 4239 40 300-20  
www.fassaden-kleben.at

#### Germany

Walter Hallschmid GmbH&Co.KG  
Wiesentraße 1  
D-94424 Arnsdorf  
Tel.: +49 (0) 8723 / 96 121  
Fax: +49 (0) 8723 / 96 127  
www.dichten-und-kleben.de

MBE GmbH  
Siemensstraße 1  
D-58706 Menden  
Tel.: +49 (0)2373 / 17430-0  
Fax: +49 (0)2373 / 17430-11  
www.mbe-gmbh.de

#### Switzerland

SIKA Chemie GmbH  
Tüffenwies 16-22  
CH-8048 Zürich  
Tel.: +41 (0) 1 / 436 40 40  
Fax: +41 (0) 1 / 270 52 39  
www.sika.ch

### PROFILES/ACCESSORIES:

#### Austria

Protektor Bauprofile GmbH  
Hirschstettnerstr. 19/Bauteil IS/ZI 318  
A-1220 Wien  
Tel.: +43 (0)1 / 259 45 00-0  
Fax: +43 (0)1 / 259 45 00-19  
www.protektor.com

Fa. Helmut Lohr  
Elisabethstraße 36  
A-2380 Perchtoldsdorf  
Tel.: +43 (0)669 / 11506880  
Fax: +43 (0)1 / 867 48 29  
info@lohrshop.com

#### Germany

Protektorwerk  
Florenz Maisch GmbH & Co.KG  
Viktoriastraße 58  
D-72571 Gaggenau  
Tel.: +49 (0)7225 / 977-0  
Fax: +49 (0)7225 / 977-111  
info@protektor.com  
www.protektor.com

#### France

PROTEKTOR S.A. BATI-PROFIL  
Rue Pasteur Prolongée  
F-94400 Vitry sur Seine  
Tel.: +33 (0)1 / 55 53 17 50  
Fax: +33 (0)1 / 55 53 17 40

### CORRECTORS (PAINTS):

#### Austria

VOTTELER Lacktechnik GmbH  
Malvenstraße 7  
A-4600 Wels  
Tel.: +43 (0)7242 / 759-0  
Fax: +43 (0)7242 / 759-113  
at.info@votteler.com  
www.votteler.com

#### Germany

Heinrich König & Co. KG  
An der Rosenhelle 5  
D-61138 Niederdorfelden  
Tel.: +49 (0)6101 / 53 60-0  
Fax: +49 (0)6101 / 53 60-11  
info@heinrich-koenig.de  
www.heinrich-koenig.de

FSG Schäfer GmbH  
Boschstraße 14  
D-48703 Stadthlohn  
Tel.: +49 (0)2563 / 9395-0  
Fax: +49 (0)2563 / 9395-25  
verkauf@fsg-schaefer.de  
www.fsg-schaefer.de



Fig. 1

**FASTENING SPACINGS**

MAX COMPACT INTERIOR		
Thickness (mm)	Fastening spacing (mm)	Projection (mm)
10	320	180
12	400	250

Table 1

**APPLICATION**

FunderMax Compact Interior panels are often used as table tops for school, desk, office, conference, lab or factory tables.

**RESISTANCE**

Due to their pore-free surfaces and excellent chemical resistance, FunderMax Compact Interior panels are very easy to clean. Further advantages of these panels include their high scratch, tear and impact resistance.

**STORAGE**

Neither tables nor table panels should be stacked as the heavy stack weight can lead to damage.

**PANEL THICKNESS**

The thickness of Max Compact Interior table panels should either be 12 mm, or at least 10 mm, in order to allow enough depth for screwing. Both panel thickness and mounting distances as well as expected load platforms, are directly linked and must be measured correspondingly.

**FASTENING**

The fastening of Compact Interior panels can be carried out in a number of different ways, however, due to the material characteristics, a linear free expansion must be considered during the mounting process. The panels can be mounted mechanically using screws. The screws can either be directly screwed into the panels or inserted using sleeve screws with internal and external threads (e.g. Rampa inserts). For this, the panels must be pre-drilled for to establish a thread. Fastening the panels using screws takes place from the underside of the material. Therefore, metric thread and flat-head screws are suitable. Washers can be used if required.

Due to compact material characteristics, the fixing points must be sliding points.

**Sliding point:** the drill diameter in the substructure must be bigger than that of the mounting material depending on the corresponding compact expansion room. The screw head should always cover the borehole. The mounting material will be attached in such a way that the panels are free to move. Screws should not be too tightly fastened. The middle point of the drilling in the substructure should correspond with the middle point of the drilling in the Max Compact.

Drill with centering sleeve! The fastening material should be attached from the middle of the panel outwards.

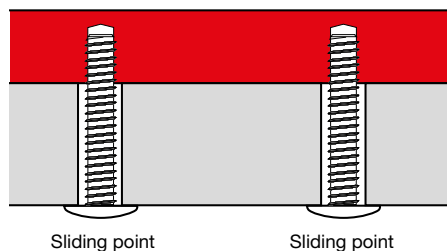

Fig. 2

Examples of use with  
Max Compact Interior 12 mm

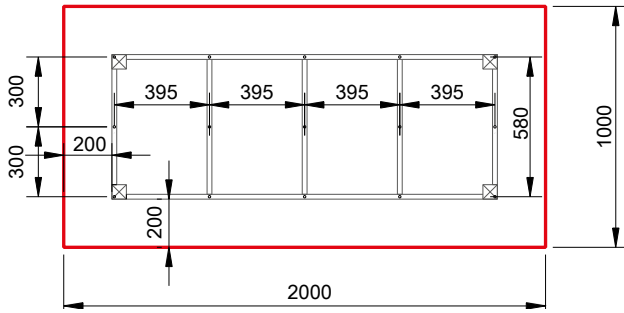

Fig. 3

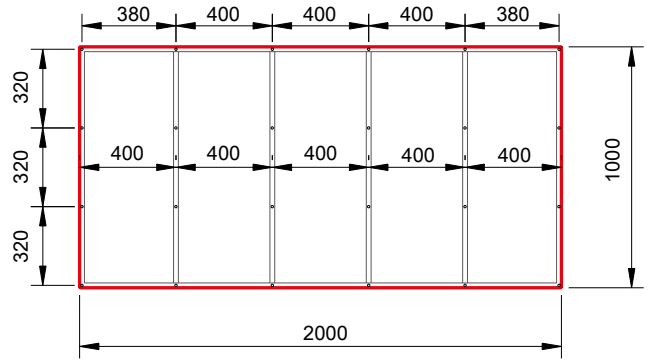

Fig. 8

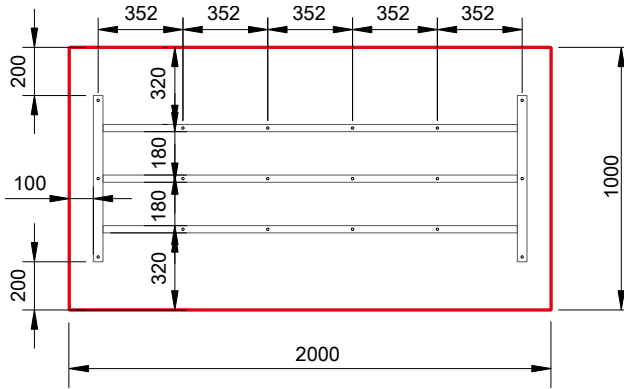

Fig. 4

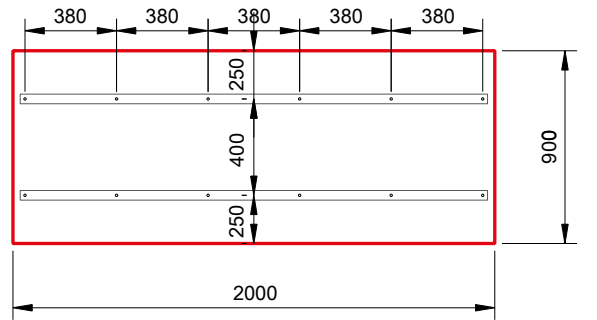

Fig. 9

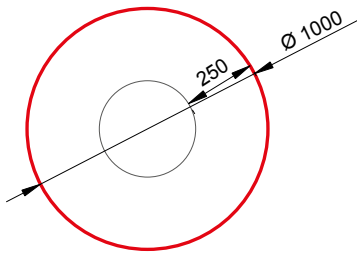

Fig. 5

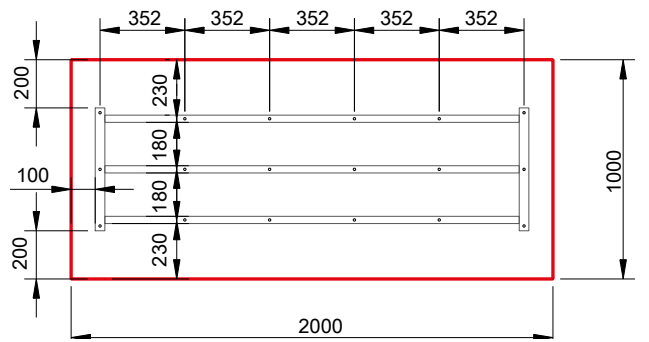

Fig. 10

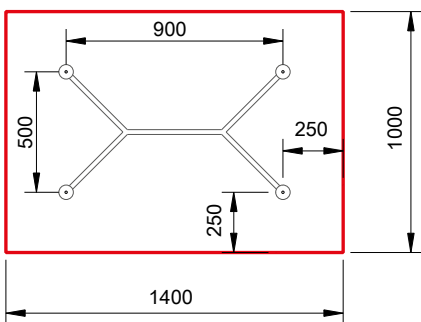

Fig. 6

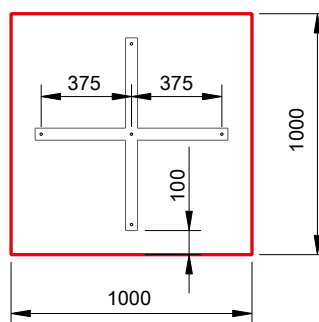

Fig. 7

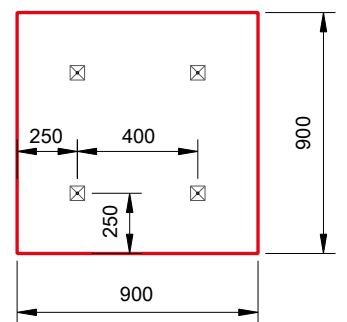

Fig. 11



Fig. 1

**CABINET BODY**

FunderMax Compact Interior panels are suitable for shopfittings, design applications, hospitals or for home and office furniture.

In principle, the same panel connections used for conventional furniture construction can be used. However, as it is not necessary to use the same panel strengths, the panels must be selected correspondingly.

Due to the material characteristics of the FunderMax Compact Interior panels, both fixed and sliding points must be drilled. During the adhesion process of FunderMax Compact Interior panels to corner joints, stumps or bevel cuts, it must be ensured that all bonded elements have the same production direction. That means adhesions must solely be made length to length and breadth to breadth. The remaining panels must always indicate the machine direction.

**CABINET DOORS**

There are only several door hinges that are suitable for the thin panel thickness and therefore, door elements such as hinges can be doubled. It is important that the same panel material in the same thickness and decor is used in order to maintain symmetry.

Reactive adhesives are suitable for the adhesion process, for e.g. epoxy or solvent free PU glues (also see adhered corpus and corner joints).



OBJECT HINGE (FA. PRAMETA) FOR COMPACT DOORS PANELS, DOOR THICKNESS 10 -13 MM. SINGLE AXIS PIVOT POINT.

Fig. 2

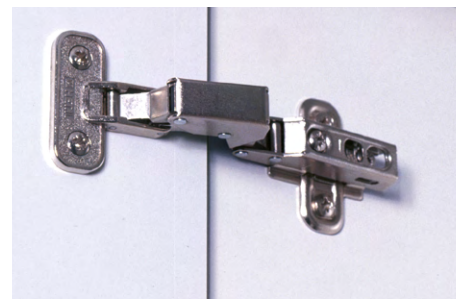

UNSCREW STRAP HINGES FOR DOORS MADE FROM COMPACT PANELS

Fig. 3



## Mechanical corner joints

Due to the largely low material thickness, the recommended means of mounting are screwing or riveting (blind rivets). The drill diameter must be selected larger than the shaft diameter of the mounting materials (dimensional changes). In keeping with the larger screw heads, setting heads on rivets or washers should be used.

Max Compact Interior corner joints can be produced along the entire length using brackets. This is particularly necessary when covering large areas but also to support adhesive joints when used in wet rooms.

If the underside of the Max Compact panel above the substructure is being drilled from behind, fixed and slide points must be considered (as described in the table tops chapter). A minimum panel thickness of 13 mm is necessary to ensure sufficient drilling material.

## Further examples of mechanical connections:

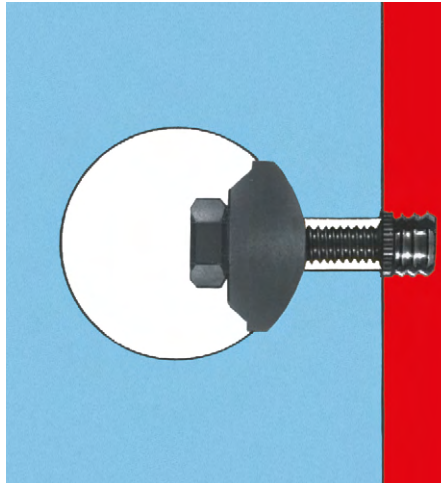

CONNECTION WITH BRASS EXPANSION BOLT Fig. 6

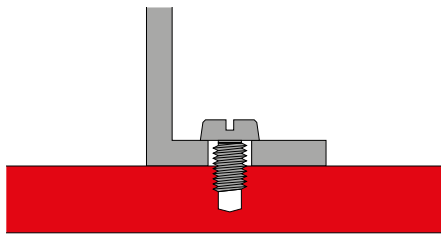

CONNECTION WITH THE TAPPED HOLE DIRECTLY INTO THE COMPACT PANEL Fig. 7

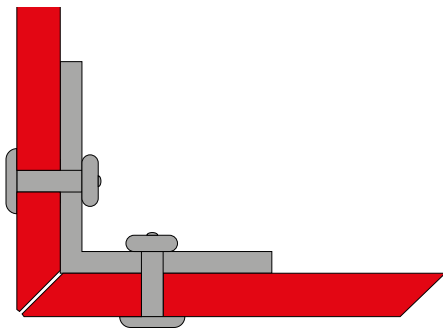

Fig. 4

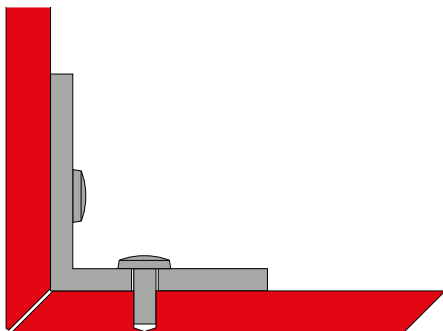

Fig. 5

Thinner panels are drilled or riveted. The fixed and sliding points are ideally inserted into the panels.

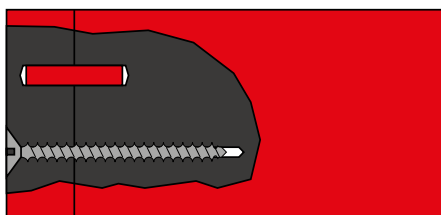
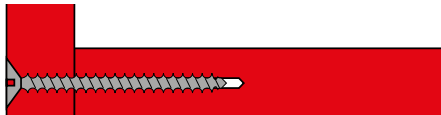

Fig. 8



Fig. 1



Fig. 3



Fig. 2



Fig. 4



Fig. 5



## Suppliers/accessories

### FITTINGS/FASTENINGS (MECHANICAL)

#### Austria

Schachermayer-  
Großhandelsgesellschaft m.b.H.  
Schachermayerstraße 2  
Postfach 3000  
A-4021 Linz  
Telefon: +43 (0)732 / 6599-0  
Fax: +43 (0)732 / 6599-1360  
info@schachermayer.at  
www.schachermayer.at

Fa. Schmidtschläger  
Kaiserstraße 41  
1070 Wien  
Tel.: 01 / 523 46 52-0  
Fax: +43 (0)6229 / 39 0 39-16  
service@schmidtschlaeger.at  
www.schmidtschlaeger.at

Häfele Austria GmbH  
Römerstraße 4  
A-5322 Hof bei Salzburg  
Tel.: +43(0)6229 / 39 0 39-0  
Fax: +43 (0)6229 / 39 0 39-30  
info@haefele.at  
www.haefele.at

#### Germany

Prämeta GmbH & Co. KG.  
Genker Str. 16  
D-53842 Troisdorf  
Tel.: +49 (0)2241 / 23 99 6-0  
Fax: +49 (0)2241 / 23 99 6-22  
info@praemeta.de  
www.praemeta.de

Häfele GmbH & Co KG  
Adolf-Häfele-Str. 1  
D-72202 Nagold  
Tel.: +49 (0)74 52 / 95-0  
Fax: +49 (0)74 52 / 95-200  
info@haefele.de  
www.haefele.com

Hettich Holding GmbH & Co. OHG  
Vahrenkampstraße 12-16  
32278 Kirchlengern  
Tel.: +49 5223 / 77-0  
Fax: +49 5223 / 77-1202  
info@de.hettich.com  
www.hettich.com

DEUTSCHE SALICE GMBH  
Rudolf-Diesel-Str. 10  
D-74382 Neckarwestheim  
Tel.: +49 (0)7133 / 9807-0  
Fax: +49 (0)7133 / 9807-16  
info.salice@deutschesalice.de  
www.deutschesalice.de

#### Netherlands

Ipex Europe B. V.  
Vonderweg 14  
NL-7468 DC ENTER  
Tel.: +31 547 384 635  
Fax: +31 547 384 637  
www.ipex-group.com

#### Switzerland

Häfele Schweiz AG  
Dammstrasse 29  
CH-280 Kreuzlingen  
Tel: +41 (0)71/686 82 00  
Fax: +41 (0)71/686 82 82  
info@haefele.ch  
www.haefele.ch

### FASTENINGS (GLUEING)

#### Austria

Fassadenklebetechnik Klug GmbH  
Zentrale  
Julius-Tandler-Platz 6/15  
A-1090 Wien  
Tel.: +43 (0)676 / 727 1724  
r.klug@fassadenklebetechnik.at  
office@fassadenklebetechnik.at  
www.fassadenklebetechnik.at

#### Germany

Walter Hallschmid GmbH&Co.KG  
Wiesentraße 1  
D-94424 Arnsdorf  
Tel.: +49 (0) 8723 / 96 121  
Fax: +49 (0) 8723 / 96 127  
www.dichten-und-kleben.de

MBE GmbH  
Siemensstraße 1  
D-58706 Menden  
Tel.: +49 (0)2373 / 17430-0  
Fax: +49 (0)2373 / 17430-11  
www.mbe-gmbh.de

#### Switzerland

SIKA Chemie GmbH  
Tüffenwies 16-22  
CH-8048 Zürich  
Tel.: +41 (0) 1 / 436 40 40  
Fax: +41 (0) 1 / 270 52 39  
www.sika.ch

### FURTHER ADHESIVE SUPPLIERS

SIKA Österreich GmbH  
Lohnergasse 3  
A-1210 Wien  
Tel.: +43 (0)1 / 278 86 11  
Fax: +43 (0)1 / 270 52 39  
www.sika.at

DKS Technik GmbH  
Gnadenwald 90A  
A-6069 Gnadenwald  
Tel.: +43 (0)5223 / 48 488-12  
Fax: +43 (0)5223 / 48 488-50  
www.dks.at

INNOTEK Industries Vertriebsgmbh  
Boden 35  
A-6322 Kirchbichl  
Tel.: +43 (0) 5332 / 71138  
Fax: +43 (0) 5332 / 72891  
www.innotec.at

SOULDAL N.V.  
Olof-Palme-Str. 13  
D-51371 Leverkusen  
Tel.: +49 (0) 214 / 6904-0  
Fax: +49 (0) 217 / 6904-23  
www.soudal.com

### PROFILES/ACCESSORIES

#### Austria

Protektor Bauprofile GmbH  
Hirschstettnerstr. 19/Bauteil IS/Zi 318  
A-1220 Wien  
Tel.: +43 (0)1 / 259 45 00-0  
Fax: +43 (0)1 / 259 45 00-19  
www.protektor.com

Fa. Helmut Lohr  
Elisabethstraße 36  
A-2380 Perchtoldsdorf  
Tel.: +43 (0)669 / 11506880  
Fax: +43 (0)1 / 867 48 29  
info@lohrshop.com

#### Germany

Protektorwerk  
Florenz Maisch GmbH & Co.KG  
Viktoriastraße 58  
D-76571 Gaggenau  
Tel.: +49 (0)7225 / 977-0  
Fax: +49 (0)7225 / 977-111  
www.protektor.com

### CORRECTORS (PAINT)

#### Austria

VOTTELER Lacktechnik GmbH  
Malvenstraße 7  
A-4600 Wels  
Tel.: +43 (0)7242 / 759-0  
Fax: +43 (0)7242 / 759-113  
at.info@votteler.com  
www.votteler.com

#### Germany

Heinrich König & Co. KG  
An der Rosenhelle 5  
D-61138 Niederdorfelden  
Tel.: +49 (0)6101 / 53 60-0  
Fax: +49 (0)6101 / 53 60-11  
info@heinrich-koenig.de  
www.heinrich-koenig.de

FSG Schäfer GmbH  
Boschstraße 14  
D-48703 Stadtlohn  
Tel.: +49 (0)2563 / 9395-0  
Fax: +49 (0)2563 / 9395-25  
verkauf@fsg-schaefer.de  
www.fsg-schaefer.de

## Worktops

Due to their high scratch and abrasion resistance as well as high impact resistance and resistance to high temperatures, Max Compact Interior panels are ideally suited for horizontal use as a worktop. Another advantage of these panels is the hygienically sealed, pore-free, closed surface made of melamine resin that is very easy to clean and is particularly resistant to many chemicals.

### PANEL THICKNESS

The optimal thickness for Max Compact Interior panels for use as worktops is 12 mm. Different panel thicknesses, fastening distances and the expected load capacity are all directly related and must be dimensioned accordingly.

## Construction Information

Max Compact Interior panels shrink when releasing moisture. Max Compact Interior panels expand when absorbing moisture. When working with and using the panels in construction, these possible dimensional changes must be taken into consideration.

The dimensions of Compact panels are influenced by changes in relative humidity. It is therefore essential to ensure there is sufficient expansion space when installing the panels. As a rule of thumb, calculate 2 mm of expansion space for each meter of panel.

- Due to the material characteristics, when connecting Max Compact Interior panels to one another (double, butt or miter), it is essential to ensure that all the parts to be connected are arranged in the same production direction. In other words, only connect horizontal with horizontal and vertical with vertical. Left over panel pieces should therefore always be marked with the production direction.
- Base cabinets and substructures should have sufficient load-bearing capacity/stiffening.
- Base cabinets and substructures should be aligned and height differences should be avoided.
- It is not recommended to make corner joints and countertop joints exclusively by gluing; these joints should always be supported by mechanical connections.

- Recesses/outlets for the sink, glass top stove, sockets, etc., must always be made with an inner radius of 5 mm. Pointed corners are not recommended.
- In general, it is important during construction and installation to ensure that the material is not subjected to accumulating moisture. The panel material must always be able to dry. It must be ensured that the rooms are adequately ventilated.
- Visible edges or edges in the handle area must be chamfered or at least broken with sandpaper to avoid injuries and material damage.
- For a perfect surface that is easy to clean, we recommend not milling the surface of Max Compact panels.
- Max Compact Interior panels with a white core have limited suitability in heavily used areas as dirt is more visible on the white surfaces.

**NOTICE:** We reserve the right to make changes that serve technical progress.



**SUBSTRUCTURE**

When installing the Max Compact Interior panel, sufficient ventilation on both sides of the panel must be ensured. Different temperatures or moisture levels in front of and behind the countertop can lead to warping of the panels. For this reason, the panels should be placed on a sufficiently stable substructure so that air circulation is guaranteed on the front and back of the panel. If the base cabinets are not strong enough, they must be reinforced with additional elements. The base cabinets and substructures should also be aligned. Any differences in height should be compensated, for example with a suitable spacer. In order to properly “ventilate” the Max Compact Interior panels, it is necessary to design the kitchen base cabinets with an open top so that an air exchange can take place.



EXAMPLE OF MECHANICAL FASTENING

Fig. 1

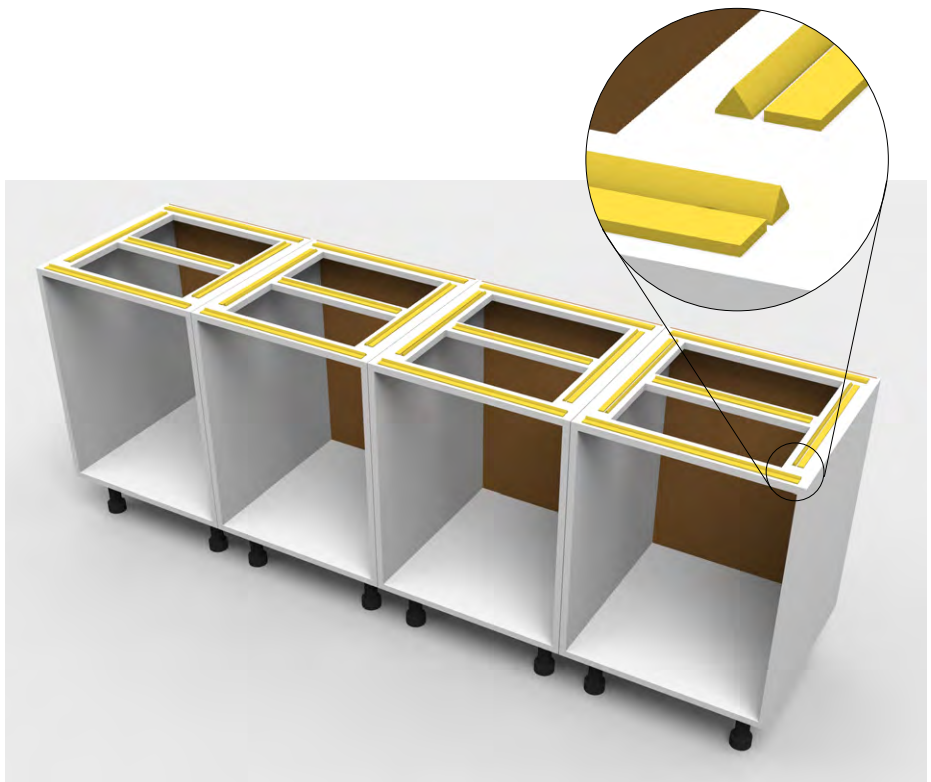

EXAMPLE OF GLUED FASTENING:

Fig. 2

## Mechanical Fastening

Due to the material characteristics of Max Compact Interior panels, the fastening points must be designed as fixed and sliding points.

### Fixed Point:

The fixed point serves the uniform distribution (halving) of the swelling and shrinkage movements. The drill hole for the fixed point in the FunderMax Compact panel should have the same diameter as the fastener. For each panel, a fixed point is placed as close as possible to the center of the panel element. All other fastening holes are designed as sliding points.

### Sliding Point:

Based on how much space is needed for expansion, the diameter of the drill hole in the substructure should be that much larger than the diameter of the fastening means. The screw head should always cover the drill hole. The fastening means is to be set such that the panel can move. The screws must not be too tight. The center of the hole in the substructure must match the center of the hole in the Max Compact panel. Drill with a centering aid!

The panels should be fastened from the middle outwards.

The Compact Interior panels can be fastened in different ways, but due to the material characteristics it is always important to ensure that they are installed in a tension-free manner. The fastening can be done mechanically with screws from the bottom. The screws can either be screwed directly into the panel or screw-in sleeves with external and internal threads (e.g. sleeves from the company Rampa) can also be used.

Should the panels be fastened directly by screw or if a screw-in sleeve is used, it should be noted that the panel must be pre-drilled one thread smaller than the screw or sleeve and that a wall thickness of at least 2.0 mm is maintained after subtracting all tolerances. Suitable screws are those with a metric thread and a flat head. Do not use counter sunk screws. If necessary, use washers/rosettes.

Please observe our recommendations for drilling blind holes vertically and parallel to the panel surface in the chapter Drilling on page 24.

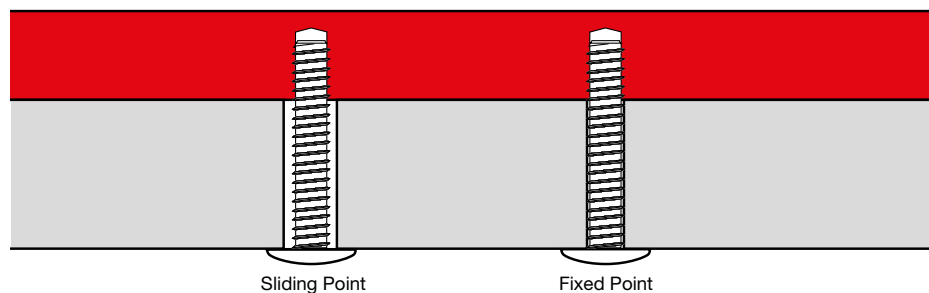

Fig. 1

**FASTENING DISTANCES FOR MECHANICAL FASTENING**

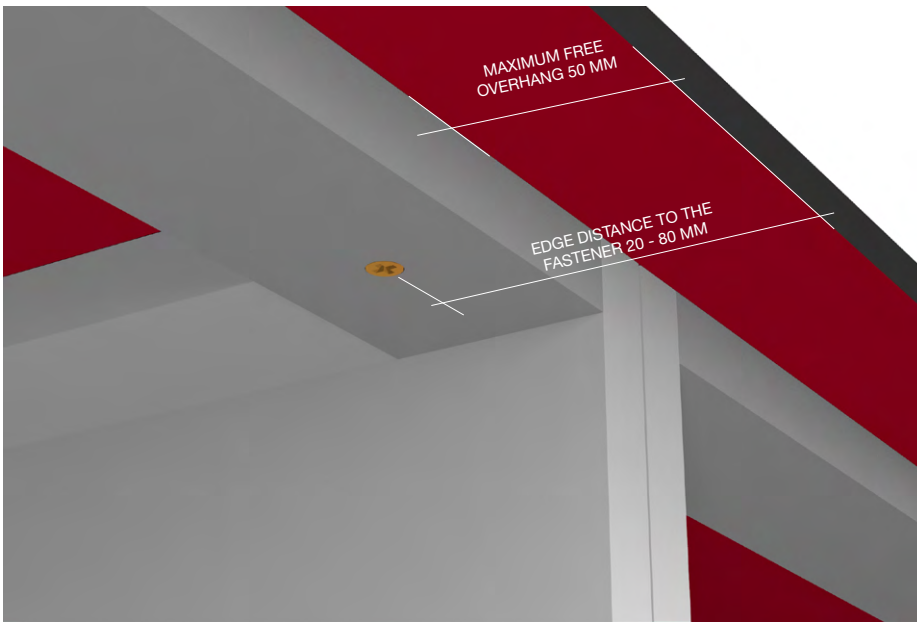

Fig. 2

MAX COMPACT INTERIOR			
Thickness (mm)	Fastening Distance (mm)	Edge Distance (mm)	Free Overhang (mm)
12	550	20-80	50

Table 1

## Glued Fastening

An alternative to the hidden, mechanical fastening is gluing the Max Compact Interior panels with especially suitable adhesive systems.

Well known facade adhesive systems from companies such as Innotec, Sika and MBE are suitable.

To align the Max Compact panels, we recommend that you only remove the cover film from the corner of the double-sided adhesive tape. This is because the weight of the panel can cause the double-sided adhesive tape to immediately adhere to its surface, making it difficult to move/align the panel.

Please observe the processing guidelines of the adhesive manufacturer. It is always recommended to test the glue first under local conditions. When working with adhesives, solvents and hardeners, the safety regulations for occupational safety must be observed.

### FASTENING DISTANCES FOR GLUED FASTENING

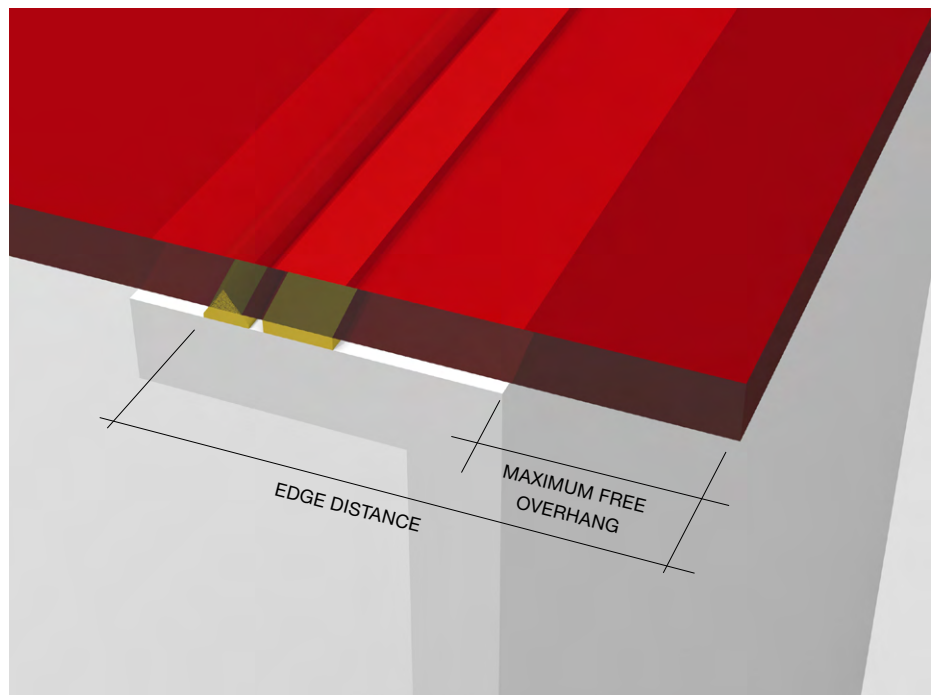

Fig. 1

MAX COMPACT INTERIOR			
Thickness (mm)	Fastening Distance (mm)	Edge Distance (mm)	Free Overhang (mm)
12	300	20-80	50

Table 1



### WORKTOP JOINTS

When making corner joints, it must be ensured that the kitchen base cabinets are aligned and any height differences should be compensated for using spacers.

Worktop joints must be made using suitable connection means. Please note when using glue for countertop joints that a wall thickness of at least 3 mm is maintained after subtracting all tolerances.

Suitable connection means for countertop joints are for example dowels, grooves, biscuits, special millings etc.

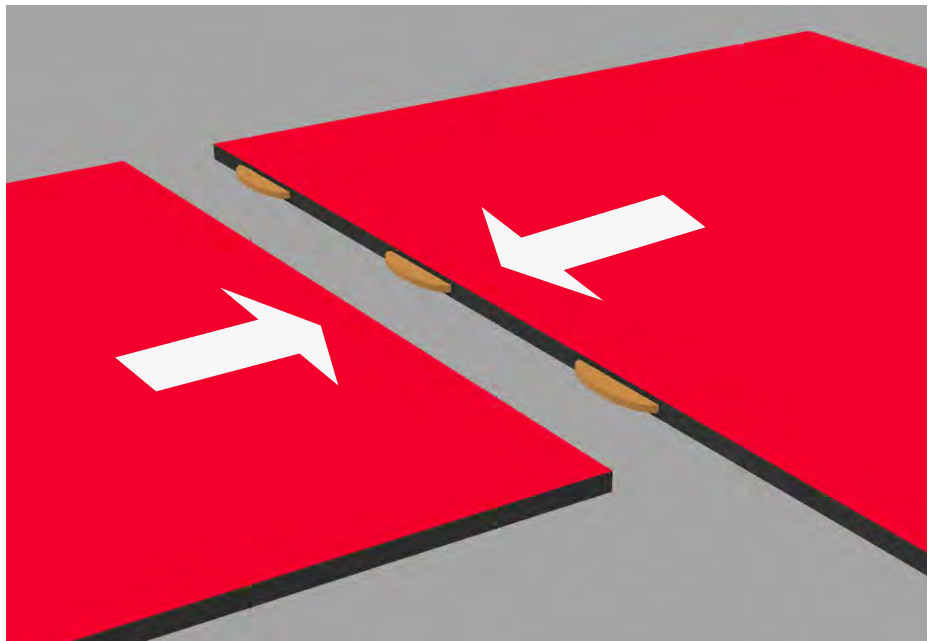

Fig. 2

Please observe our recommendations for drilling blind holes vertically and parallel to the panel surface in the chapter Drilling on page 24.

Using only glue for worktop joints is not recommended! Glued corner joints and worktop extensions should always be supported with mechanical connections.

When making worktop joints and connections to other furniture parts, walls, etc., please observe the necessary expansion space for a tension-free movement of the Max Compact Interior panels.

## Sink and Glass Top Stove Installation

When installing glass top stoves and sinks, please observe the following:

- Due to the material characteristics of Max Compact Interior panels, it must be ensured that there is sufficient expansion space when installing the panels. As a rule of thumb, calculate 2 mm of expansion space for each meter of panel.
- Recesses/outlets must always be made with an inner radius of at least 5 mm. Pointed corners are not recommended.
- Please ensure that all loads can be borne by the entire construction (e.g. with a full sink).
- When milling the Max Compact panels, make sure that at least 50% of the panel thickness remains. For a 12 mm worktop made of Max Compact panels, the milling depth should be no more than 6 mm. In the case of deeper milling, additional support of the worktop with a suitable substructure in this area is recommended.
- For a perfect surface that is easy to clean, we recommend not milling the surface of Max Compact panels.

### INSTALLATION OF GLASS TOP STOVES

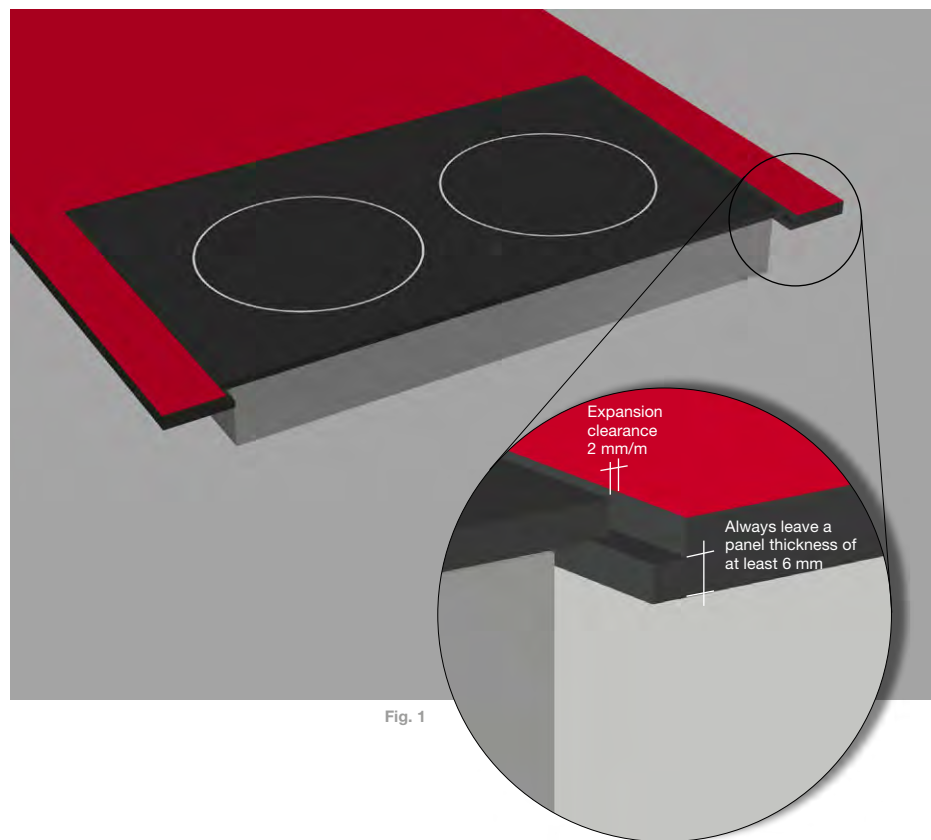
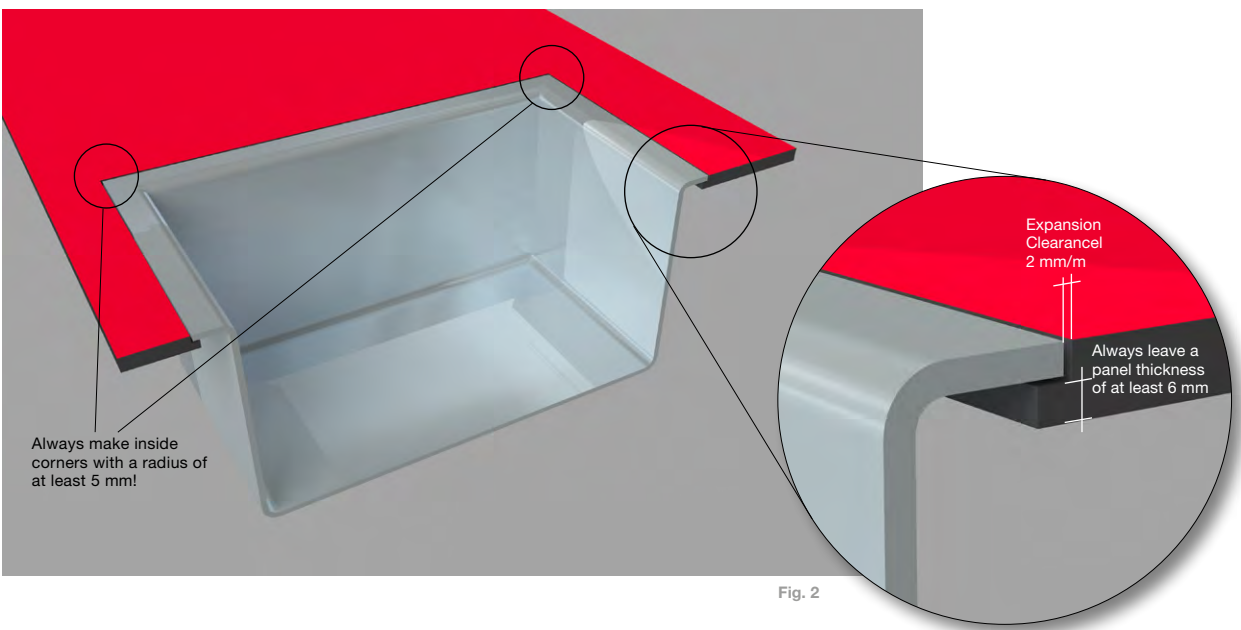

Fig. 1

**INSTALLATION OF A RECESSED SINK**



**INSTALLATION OF BOTTOM MOUNT SINKS**

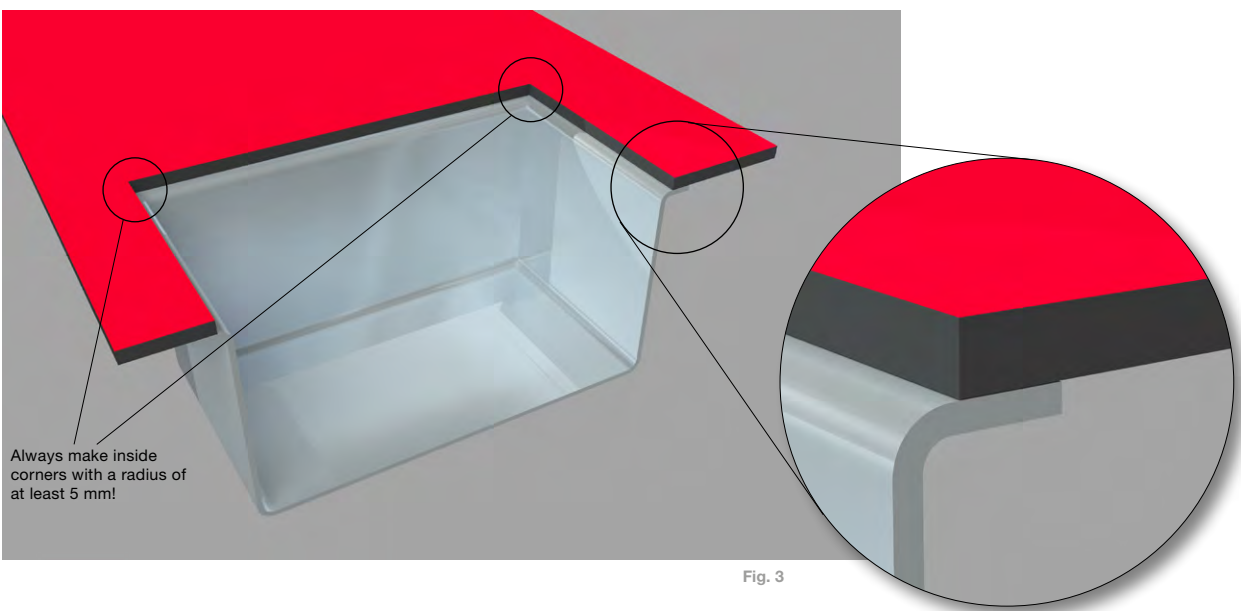



Fig. 1

Max Compact Interior panels are particularly suitable for furniture construction, bathroom fittings, office furniture, shopfittings and a wide range of design applications.

Depending on the use, Max Compact Interior panels can be used in furniture construction using the standard adhesive systems to join or mount materials together or to clad a corresponding sub-structure.

## Construction advice

FunderMax Compact Interior panels shrink at the release of moisture and expand upon the intake of moisture. These possible dimensional changes of the panels must be taken into consideration during the processing and construction process. Metal constructions change their dimensions according to variations in temperature. However, the dimensions of compact panels change under the influence of varying degrees of relative air moisture. These dimensional changes of structures and panels can work in opposing directions. Therefore, it is important to ensure sufficient expansion room during the mounting process.

A rule of thumb for the required expansion clearance is: 2 mm/metre.

- Due to the material characteristics, it is imperative that during the adhesion process of FunderMax Compact Interior panels to one another (corner joints, stumps or bevel cuts), all bonded parts have the same fibre direction. This means that attachments should be made solely length to length and breadth to breadth. The remaining panels must always indicate the production direction. Corner joints must be mechanically supported through the use of dowels, springs, special milling procedures etc.

- For high levels of moisture a mechanical connection of joints is indispensable when combined with an elastic and watertight bonding adhesive system.

- Throughout the construction and mounting process it is particularly important to ensure that the material is not exposed to stagnated moisture. The panel material must always be able to dry out. For use in wet rooms e.g. bathrooms, a sufficient ventilation system in the room is important.

- Visible edges, or edges within reach must be bevelled or at least sanded down using sand paper in order to prevent injuries or damages to the material.

We do not recommend to mill the surface of FunderMax Compact with white core to maintain the perfect cleanability.

Please consult our application engineers. We reserve the right to make changes in line with technical progress.



## Installation possibilities for wash basins using Max Compact panels

### THE SIMPLE SOLUTION:

Cutting out/screwing in an 'insertable wash basin'

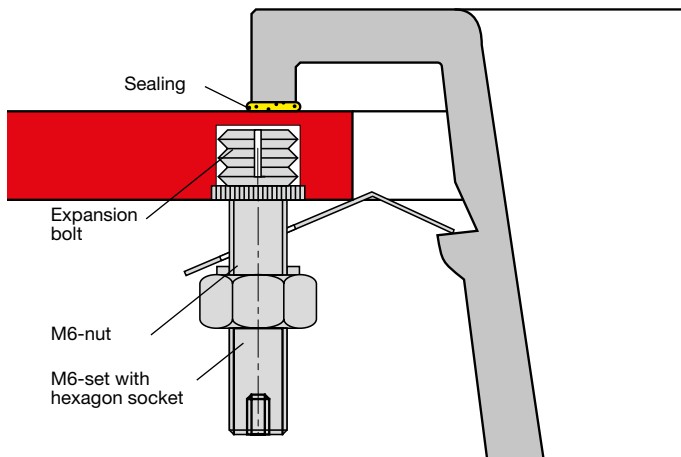

Fig. 2

### THE RATIONAL SOLUTION:

The milling of Max Compact panels and the unscrewing of the built-in wash basin. For high quantities of components, the milling can be done with a table router using templates.

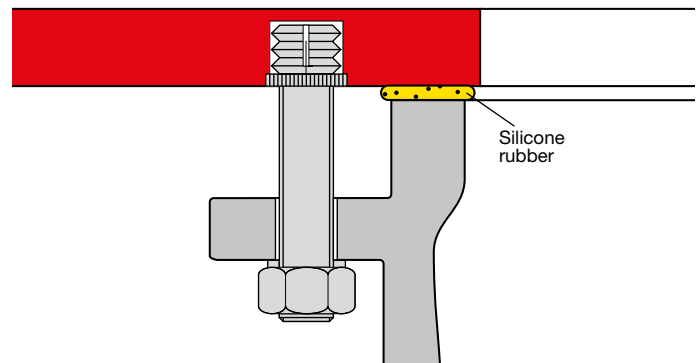

Fig. 3

**Note:** Max Compact Interior panels with a white core have limited suitability in heavily used areas as dirt is more visible on their surfaces.

### THE ELEGANT SOLUTION:

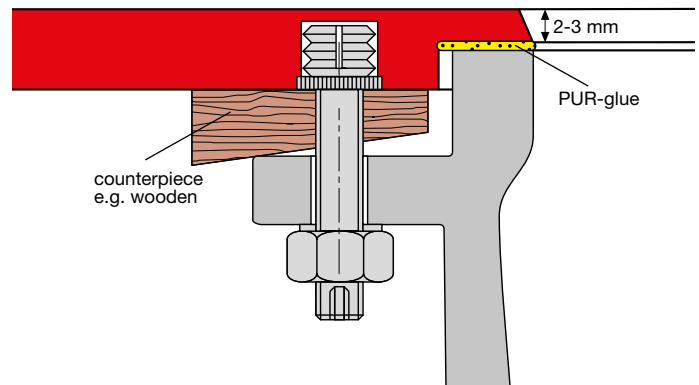

Fig. 4



Fig. 3

## General information

FunderMax Compact panels can be mounted in different ways onto railings and balustrades. They can be screwed or riveted onto a supporting structure and they can also be fixed using glass clamps.

FunderMax Compact Interior panels shrink at the release of moisture and expand upon the intake of moisture. These possible dimensional changes of the panels must be taken into consideration during the processing and construction process. Metal constructions change their dimensions according to variations in temperature. However, the dimensions of compact panels change under the influence of varying degrees of relative air moisture. These dimensional changes of structures and panels can work in opposing directions. Therefore, it is important to ensure sufficient expansion space during the mounting process. As a rule of thumb, a necessary expansion room of: 2 mm/metre applies.

## Construction advice

- FunderMax Compact Interior panels should only ever be mounted as infill panels for supporting substructures.
- Throughout the construction and mounting process it is particularly important to ensure that the material is not exposed to stagnated moisture. The panel material must always be able to dry out.
- Due to the material characteristics, it must thoroughly be ensured that during the adhesion process of FunderMax Compact Interior panels to one another (corner joints, stumps or bevel cuts), all bonded parts have the same production direction. This means that attachments should be made solely length to length and breath to breadth. The remaining panels must always indicate the production direction.
- The substructure must be protected against corrosion (rotting).
- All edges within reach must be sanded, V-joints form between the panel joint.

PLEASE CONTACT OUR TECHNICAL SUPPORT.  
WE RESERVE THE RIGHT TO MAKE CHANGES THAT  
EFFECT THE TECHNICAL PROGRESS.

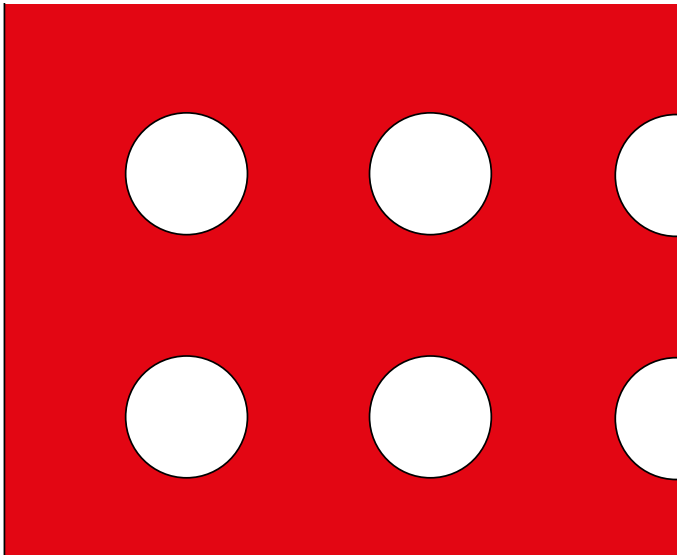

MINIMUM DISTANCES BETWEEN PERFORATIONS WITH FALL PROTECTION

Fig. 2



STAIR RAILING - HOLE MILLING

Fig. 3

**The following should be observed for railing fillings with hole patterns**

- The panel thickness is directly related to the mounting distance.
- The mounting brackets must comply with the static requirements and local building regulations, however, for perforated panels the distance between the brackets must be reduced by at least 20%.
- Holes or slots must be arranged such that children can not use them for climbing. Holes should not be larger than 50 mm in diameter.
- For recesses in FunderMax Compact Interior panels, we recommend using thicker panels in accordance with fall protection standards.
- The webs between the holes, or slots must be at least as wide as the diameter of the holes or slots. This also applies for distances from the edge.

PLEASE CONTACT OUR TECHNICAL SUPPORT. WE RESERVE THE RIGHT TO MAKE CHANGES THAT EFFECT THE TECHNICAL PROGRESS.

**FASTENING POINTS**

There are almost always 3 fastening points in every direction. Structural evidence must be shown. The stability of the railing will be guaranteed by the processor. We would like to point out, that this information relates to height distances and can only be used for flawless connections. Adequate screw and rivet dimensions must be adhered to.

Please take note: in our brochure 'technique exterior' we demonstrate different mounting possibilities for railings with compact panels, which have all been tested and approved by the 'ETB guidelines for structural elements that protect against falls' (from 6.1.85).

The "Technical Information Exterior" documentation can be found on our homepage under "Download".

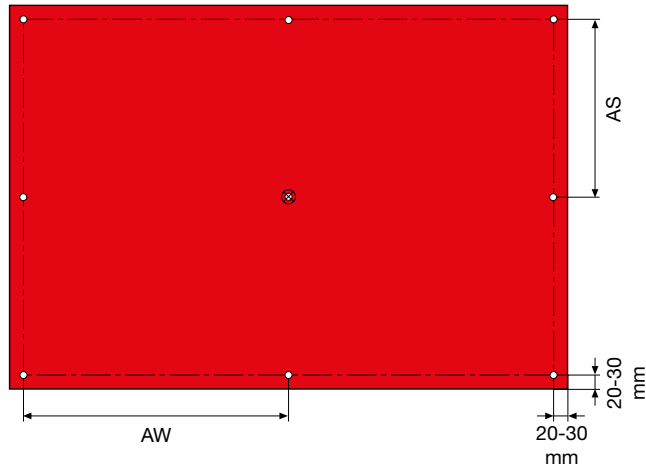

⊗ FASTENING SPACINGS  
FIXED POINT

Fig. 1

FASTENING SPACINGS FOR SCREWED AND RIVETED JOINTS			
Max Compact panel Thickness in mm	AW in mm	AS in mm	E in mm
8	≤ 1000	≤ 400	20-200
10	≤ 1100	≤ 500	20-250

Table 1

MOUNTING DISTANCES FOR BALCONY SCREWS			
Max Compact panel Thickness in mm	AW in mm	AS in mm	E in mm
8	≤ 950	≤ 450	20-160
10	≤ 1100	≤ 500	20-200

Table 2

MOUNTING DISTANCES FOR CLAMPING BRACKETS			
Max Compact panel Thickness in mm	AW in mm	AS in mm	E in mm
8	≤ 950	≤ 350	20-200
10	≤ 1000	≤ 400	20-250

Table 3

**FASTENING VARIETIES**

**A)** Direct fastening using blind rivets with flat round-head of 5.0 x 21 stainless steel and rivet washers NR 8; inner diameter 5.1 mm. Set rivets with hinge tips.

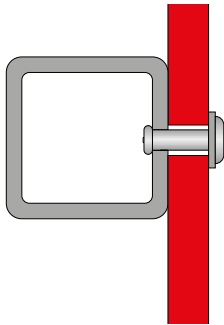

VARIANT A

**B)** Mounting devices screwed to the railing tube (e.g.: Schüco, Alu König Stahl, Längle)

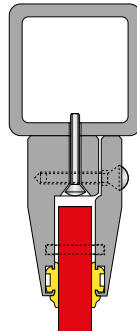
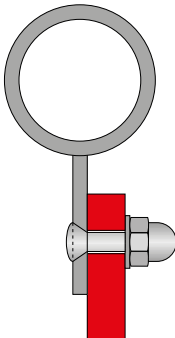

Fig. 2 VARIANT B

Fig. 3

**C)** Welded steel handles with raised counter-sunk head screws M6 x 20 DIN 964 and cap nut M6 DIN 1587 (stainless steel).



VARIANT C

**D)** Welded steel handles with two clamping plates and hexagon bolts M6 x 25 DIN 933, cap nut M6 DIN 1587 and sheets M6 DIN 121 A (stainless steel).

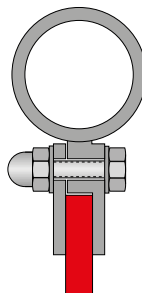
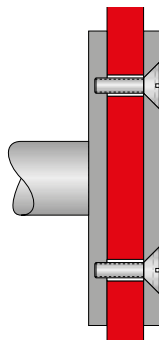

Fig. 4 VARIANT D

Fig. 5

**E)** Mounting of Max Compact panels with pairs of circular plates Ø ... mm; 5 mm thick. The base plates are welded to aligned projections jutting from vertical rail stanchions. The cover plates are screwed with 2 stainless steel countersunk screws (M6 x 20 DIN 963) through the drill holes in the Max Compact panel (expansion clearance!) to the base plates.



VARIANT E

Fig. 6

## Suppliers/accessories for railings

### VARIOUS ACCESSORIES::

Schachermayer  
Großhandelsgesellschaft mbH  
Schachermayerstr. 2-10  
A-4021 Linz  
Tel.: +43 (0)732 / 6599 - 0  
Fax: +43 (0)732 / 6599 - 1360  
zentrale@schachermayer.at  
www.schachermayer.at

Hueck + Richter Aluminium  
GmbH  
Rossakgasse 8  
A-1230 Wien  
Tel.: +43 (0)1 / 667 15 29-0  
Fax: +43 (0)1 / 667 15 29-0  
www.hueck.at

Pauli + Sohn GmbH  
Eisenstraße 2  
D-51545 Waldbröl  
Tel.: +49 (0)2291 / 9206-0  
Fax: +49 (0)2291 / 9206-681  
www.pauli.de

SWS Ges. f. Glasbaubeschläge  
Friedrich-Engels-Straße 12  
Tel.: +49 (0)2291 / 7905-0  
Fax: +49 (0)2291 / 7905-10  
D-51545 Waldbröl  
info@sws-gmbh.de  
www.sws-gmbh.de

Lauterbach GmbH  
Heraeusstraße 22  
D-06803 Bitterfeld-Wolfen/OT  
Greppin  
Tel.: +49 (0)3493 / 82 76 76  
Fax: +49 (0)3493 / 92 29 06  
info@lauterbach-gmbh.com  
www.lauterbach-gmbh.com

ALUKÖNIGSTAHL GmbH  
Goldschlagstrasse 87-89  
A-1150 Wien  
Tel.: +43 (0)1 / 98 130-0  
Fax: +43 (0)1 / 98 130-64  
office@alukoenigstahl.com  
www.alukoenigstahl.com

SCHÜCO International KG  
Karolinenstraße 1-15  
D-33609 Bielefeld  
Tel.: +49 (0)521 / 7830  
Fax: +49 (0)521 / 78 34 51  
info@schueco.com  
www.schueco.com

NORMBAU  
Beschläge und Ausstattungs  
GmbH  
Schwarzwaldstrasse 15  
D-77871 Renchen  
Tel.: +49 (0)78 43 / 7 04-0  
Fax: +49 (0)78 43 / 7 04-43  
info@normbau.de  
www.normbau.de

HEWI Heinrich Wilke GmbH  
Prof.-Bier-Straße 1-5  
D-34454 Bad Arolsen  
Telefon: +49 5691 82-0  
Telefax: +49 5691 82-319  
info@hewi.de  
www.hewi.de

FUNDERMAX ASSUMES NO LIABILITY FOR THE PRODUCTS OF THE COMPANIES LISTED REGARDING THE QUALITY AND SUITABILITY FOR SPECIFIC APPLICATIONS.

## Exclusion of Liability

The information made available in this document are exclusively for purposes of general information.

Not all of the systems mentioned and shown in this document are appropriate or suitable for all areas of application.

All customers and third parties are obligated to inform themselves thoroughly about FunderMax products, including their suitability for certain purposes.

We explicitly recommend that you and other users of this document seek out independent expert advice on adherence to local planning and use requirements, applicable laws, regulations, standards, guidelines and testing standards.

FunderMax accepts no liability in connection with the use of this document.

Responsibility for correct and appropriate planning and workmanship lies exclusively with those planning or processing the materials

All of our spoken and written statements, offers, bids, sales, shipments and contracts, as well as all activities associated therewith, are subject to FunderMax GmbH's terms and conditions of sales and delivery in the currently valid version, which can be found on our website [www.fundermax.at](http://www.fundermax.at).

### COPYRIGHT

ALL TEXTS, PHOTOGRAPHS, GRAPHICS, AND AUDIO AND VIDEO FILES ARE PROTECTED BY COPYRIGHT LAW AS WELL AS BY FURTHER INTELLECTUAL PROPERTY LAWS AND MAY NOT BE DUPLICATED, ALTERED OR USED ON OTHER WEBSITES FOR PURPOSES OF BUSINESS, ETC.

FUNDERMAX DEUTSCHLAND GMBH  
Industriestrasse 1  
D-92442 Wackersdorf  
infoGermany@fundermax.biz  
www.fundermax.de

FUNDERMAX FRANCE SARL  
3 Cours Albert Thomas  
F-69003 Lyon  
Tel.: +33(0)4 78 68 28 31  
Fax: +33(0)4 78 85 18 56  
infoFrance@fundermax.at  
www.fundermax.fr

FUNDERMAX ITALIA S.R.L.  
Viale Venezia 22  
I-33052 Cervignano del Friuli  
infoItaly@fundermax.biz  
www.fundermax.it

FUNDERMAX INDIA PVT. LTD.  
No. 13, 1st Floor, 13th Cross  
Wilson Garden  
IND-560027 Bangalore  
Tel.: +91 80 4112 7053  
Fax: +91 80 4112 7053  
officeIndia@fundermax.biz  
www.fundermax.at

FUNDERMAX POLSKA SP. Z O.O.  
ul. Rybitwy 12  
PL-30 722 Kraków  
Tel.: +48-12-65 34 528  
Fax: +48-12-65 70 545  
infoPoland@fundermax.biz

FUNDERMAX SWISS AG  
Industriestrasse 38  
CH-5314 Kleindöttingen  
Tel.: +41 (0) 56-268 83 11  
Fax: +41 (0) 56-268 83 10  
infoSwiss@fundermax.biz  
www.fundermax.ch

FUNDERMAX NORTH AMERICA, INC.  
9401-P Southern Pines Blvd.  
US-Charlotte, NC 28273  
Tel.: +1 980 299 0035  
Fax: +1 704 280 8301  
office.america@fundermax.biz  
www.fundermax.at

## **FunderMax GmbH**

Klagenfurter Straße 87–89, A-9300 St. Veit / Glan  
T +43 (0) 5/9494- 0, F +43 (0) 5/9494-4200  
office@fundermax.at, www.fundermax.at